

Planning Guidelines

SMA SMART HOME

The System Solution for Greater Independence



Table of Contents

1	Information on this Document.....	4
1.1	Content and Structure of this Document.....	4
1.2	Symbols in the Document.....	5
1.3	Designation in the document	5
2	PV Energy for Internal Power Supply and Self-Consumption	6
2.1	Why are Self-Consumption and Internal Power Supply Interesting?	6
2.2	What Are the Effects of Internal Power Supply and Self-Consumption?.....	6
2.3	What Are the Requirements for High Energy Self-Sufficiency and Self-Consumption Quotas?	6
2.4	Increased Self-Consumption Through Intelligent Energy Management	7
3	Internal Power Supply and Self-Consumption with SMA Smart Home.....	10
3.1	Basic Solution for Intelligent Energy Management	10
3.2	Simple Storage Solution for New PV Systems	11
3.3	Flexible Storage Solution for New and Existing PV Systems.....	13
4	Functions for Energy Management Systems.....	19
4.1	Load Control	19
4.1.1	Energy Monitoring - Measuring and Understanding Energy Flows	19
4.1.2	Visualization of PV System Data in Sunny Portal	19
4.1.3	Components of Load Control	20
4.1.4	Mode of Operation of Load Control	21
4.1.5	Application Examples	22
4.1.6	Distinguishing Between Self-Consumption Systems and Feed-In Systems in SMA Smart Home.....	22
4.2	Dynamic Limitation of Active Power Feed-In to Avoid Derating Losses.....	23
4.2.1	General information regarding the limitation of active power feed-in.....	23
4.2.2	Avoiding Derating Losses Through Forecast-Based Battery Charging in SMA Storage Solutions	24
4.2.3	Example of Avoiding Derating Losses with Forecast-Based Battery Charging	28
4.3	Power Control at the Grid-Connection Point.....	29
4.3.1	General Power Control.....	29
4.3.2	Limitation of Active Power Feed-In to 0% or 0 W	29
4.3.3	Avoiding Unbalanced Load	30
4.3.4	Power Control in Accordance with the Summation Current Principle.....	31
5	Loads in Energy Management Systems	35
5.1	Suitability of Loads for an Energy Management System	35
5.2	Options for Load Control	35
5.3	Control of Heat Pumps	36
5.3.1	ON/OFF Heat Pumps	36
5.3.2	Inverter Heat Pumps	37
6	Components for Energy Management Systems	38
6.1	Product Overview	38
6.1.1	SMA and Radio-Controlled Sockets for Basic Solution	38
6.1.2	SMA and Radio-Controlled Sockets for Simple Storage Solution	38
6.1.3	SMA and Radio-Controlled Sockets for Flexible Storage Solution.....	38
6.2	Home appliances with intelligent communication interface.....	39
6.3	PV Inverters	40
6.3.1	PV Inverters with Sunny Home Manager.....	40
6.3.2	PV Inverters in the SMA Integrated Storage System.....	42
6.3.3	PV Inverters in the SMA Flexible Storage System	43
6.4	Radio-Controlled Sockets for Load Control	43

6.5	Energy Measuring Device SMA Energy Meter	44
6.6	Communication	44
6.7	Maximum Number of Devices in the Energy Management System	44
7	SMA Flexible Storage System.....	46
7.1	Circuitry Overview for a System with One Sunny Island Inverter	46
7.2	Material for Circuitry of the System with One Sunny Island.....	47
7.3	Circuitry Overview for a System with One Sunny Boy Storage	48
7.4	Material for Circuitry of the System with One Sunny Boy Storage	49
7.5	Circuitry Overview for a System with Three Sunny Island Inverters	50
7.6	Material for Circuitry of the System with Three Sunny Island Inverters.....	51
7.7	Supported Batteries	51
7.8	System Design of an SMA Flexible Storage System with Diagrams.....	51
8	PV System Design with Sunny Design.....	58
9	Frequently Asked Questions	59
10	Explanation of Used Terms	63
11	Appendix	65
11.1	Country-Dependent Availability of the SMA Products	65
11.2	Planning Mounting Locations.....	66





1 Information on this Document

1.1 Content and Structure of this Document

This document provides support when you are planning an energy management system with the system solution SMA Smart Home. The contents of the following sections build on each other.

Section	This section answers the following questions:
PV Energy for Internal Power Supply and Self-Consumption (see Section 2, page 6)	What are the effects of internal power supply and self-consumption? What are the requirements for high energy self-sufficiency and self-consumption quotas? What product solutions for intelligent energy management are offered by SMA Solar Technology AG in the context of SMA Smart Home?
Internal Power Supply and Self-Consumption with SMA Smart Home (see Section 3, page 10)	How does the basic solution for intelligent energy management work and how is it set up? How does the SMA Integrated Storage System work and how is it set up? How does the SMA Flexible Storage System work and how is it set up?
Functions for Energy Management Systems (see Section 4, page 19)	How does the intelligent load control work? How does the dynamic limitation of active power feed-in for prevention of derating losses work? How does forecast-based charging for prevention of derating losses work? How does the power control at the grid-connection point work? How does active power feed-in limitation to 0% or 0 W work? What functions are available for intelligent load control? How does intermediate storage work in principle? How does power control at the grid-connection point work for the individual SMA product solutions?
Loads in Energy Management Systems (see Section 5, page 35)	Which loads are suitable for energy management systems? What is to be considered when using these loads?
Components for Energy Management Systems (see Section 6, page 38)	Which SMA products belong to the SMA product solutions offered? What other products are required?
SMA Flexible Storage System (see Section 7, page 46)	What must be considered during the design of an SMA Flexible Storage System?
Appendix (see Section 11, page 65)	In which countries are the SMA product solutions for energy management available? What has to be considered when planning the mounting locations?

1.2 Symbols in the Document

Symbol	Explanation
	Information that is important for a specific topic or goal, but is not safety-relevant
	Indicates a requirement for meeting a specific goal
	Desired result
	A problem that might occur
	Example

1.3 Designation in the document

Complete designation	Designation in this document
SMA Energy Meter (EMETER-20)	SMA Energy Meter
Sunny Boy Smart Energy, Sunny Boy Storage, Sunny Island	Battery inverter
Sunny Boy, Sunny Tripower	PV inverter
Sunny Home Manager 2.0	Sunny Home Manager
Sunny Island 4.4M (SI4.4M-12), Sunny Island 6.0H (SI6.0H-12), Sunny Island 8.0H (SI8.0H-12)	Sunny Island

2 PV Energy for Internal Power Supply and Self-Consumption

2.1 Why are Self-Consumption and Internal Power Supply Interesting?

In light of the continuing trend towards lower feed-in tariffs, the focus of system design has increasingly shifted away from maximizing PV generation towards intelligent energy management. There are two key objectives here:

- As much self-consumption of the generated PV energy as possible
- Full coverage of the energy requirement with PV energy (= self-sufficiency) if possible

Both of these are economically viable as soon as the PV generation costs fall below the costs of purchasing electricity.

2.2 What Are the Effects of Internal Power Supply and Self-Consumption?

An almost total self-consumption of the PV energy makes the operator more independent of the feed-in tariff which now barely covers costs, and it increases the effective value of each generated kilowatt hour. An almost complete internal power supply makes the operator more independent of rising electricity prices and reduces the average cost of each kilowatt hour used.

Internal power supply and self-consumption also relieve the burden on the utility grid since the energy produced on site is also consumed directly on site. For this reason, the importance of technical solutions for optimization of internal power supply and self-consumption is growing constantly.

Normally, self-consumption of PV energy takes place naturally. Whenever a load is switched on while the sun is shining, the PV energy generated at that time is consumed directly.

This means that the energy generated by the PV system naturally flows first to the active loads within the household grid – only the surplus flows into the utility grid. For this reason, a primary function of energy management is to intelligently coordinate the operation of loads with the availability of PV energy, with regard to both quantity and time.

2.3 What Are the Requirements for High Energy Self-Sufficiency and Self-Consumption Quotas?

The first important requirement for effectively increasing the internal power supply and self-consumption is the right balance between annual PV generation and annual energy demand:

- If the annual PV generation is considerably lower than the annual energy demand, a significant proportion of the PV energy can almost always be used on site. This also applies when the timing of the main energy demand and the main PV generation do not coincide exactly. The high self-consumption quota is then purchased with a low self-sufficiency quota.
- If, however, the annual PV generation is much higher than the annual energy demand, only a small proportion of the PV energy can be used on site. Much of the generated PV energy must be fed into the utility grid. This results in a low self-consumption quota. The self-sufficiency quota, on the other hand, is higher.

A changed ratio of PV generation to electrical consumption, therefore, always increases either the self-sufficiency quota or the self-consumption quota. For this reason, the right balance between energy generation and energy consumption is indispensable.

A second important requirement for a high self-sufficiency quota and a high self-consumption quota is an appropriate load profile: The distribution schedule of the PV power is defined in quite narrow limits by the alignment of the PV array and the weather. For this reason, the load profile determines almost solely how well PV generation and energy demand match each other during the course of the day. Besides using electrical storage systems, effective matching of the load profile is the only way to simultaneously optimize both the self-sufficiency quota and the self-consumption quota.

i Parameters for internal power supply and self-consumption

The internal power supply is specified by the self-sufficiency quota.

The self-consumption is specified by the self-consumption quota.

2.4 Increased Self-Consumption Through Intelligent Energy Management

If the ratio of PV generation and energy demand remains constant, internal power supply and self-consumption can only be optimized by intelligent energy management. For this purpose, SMA Solar Technology AG offers the following product solutions:

- Basic solution for intelligent energy management: Sunny Home Manager and radio-controlled sockets
- Simple storage solution for new PV systems: SMA Integrated Storage System
- Flexible storage solution for new and existing PV systems: SMA Flexible Storage System

Sunny Home Manager and Radio-Controlled Sockets – Basic Solution for Intelligent Energy Management

The first step in intelligent energy management is the recording and evaluation of the energy flows in the household. This energy monitoring looks at both the total energy consumption and that of individual home appliances using the measurement function of the radio-controlled sockets.

Based on the information compiled in this way, the Sunny Home Manager creates an overview with various views and diagrams in Sunny Portal. The user can then use this overview to understand the energy flows in his/her household and can decide in which areas it is worth deploying intelligent energy management.



The Sunny Home Manager also provides recommendations on the times at which the user can switch on specific devices in order to significantly increase self-consumption.

The next step is active energy management in the form of automatic load control in the household. Via the on/off switch function of the radio-controlled sockets or via control commands through data connection, loads can be switched on by the Sunny Home Manager precisely when the PV system is generating sufficient energy or when the energy costs are particularly low.



Optimization of energy utilization

We assume a typical, single-family home with an annual PV generation of 5000 kWh, an annual energy demand of 5000 kWh, and a natural self-consumption of 30%. In this example, the Sunny Home Manager can improve the energy balance through intelligent load control as follows:

- Due to the high direct consumption by the controlled loads, the self-consumption quota increases from 30% to typically 45%.
- Accordingly, the purchased electricity amount decreases from 3500 kWh to 2750 kWh per year. This equals 55% of the entire annual energy demand. The electricity bill is decreased by 22%.

SMA Integrated Storage System – the Simple Storage Solution for New PV Systems

With an electrical storage system, you can intermediately store PV energy. This intermediate storage supplements the automatic load control and further increases internal power supply and self-consumption. The SMA Integrated Storage System provides a simple storage solution that is designed for extremely efficient operation.



The most important elements are a Sunny Boy Smart Energy and an SMA Energy Meter. The Sunny Boy Smart Energy is a PV inverter with integrated lithium-ion storage (storage capacity: 2 kWh). The SMA Energy Meter can also be optionally replaced by the Sunny Home Manager 2.0. This enables intelligent energy management.



Optimization of energy utilization

We assume a typical, single-family home with an annual PV generation of 5000 kWh, an annual energy demand of 5000 kWh, and a natural self-consumption of 30%. In this example, the SMA Integrated Storage System uses the available battery capacity of 2 kWh to optimize the energy balance as follows:

- Due to the additional usable energy from the battery-storage system, the self-consumption quota increases from 30% to typically 55%.
- Accordingly, the purchased electricity amount decreases from 3500 kWh to 2400 kWh. The purchased electricity of 2400 kWh corresponds to 48% of the annual energy demand; this includes storage losses of 3%. The electricity bill is decreased by 32%.

SMA Flexible Storage System – the Flexible Storage Solution for New and Existing PV Systems

The SMA Flexible Storage System can be fitted with a customized battery-storage system. The inverter power and the system size can also be selected to suit the requirements of each household. The SMA Flexible Storage System can be based on two different battery inverters: the Sunny Island for low-voltage batteries or the Sunny Boy Storage for high-voltage batteries.

The most important elements of an SMA Flexible Storage System with Sunny Island are one or more SMA PV inverters, one or more Sunny Island inverters, a battery, an SMA Energy Meter or a Sunny Home Manager 2.0. The Sunny Island is a battery inverter for parallel grid and stand-alone mode. Three Sunny Island inverters can be connected to form a three-phase cluster.



The most important elements of an SMA Flexible Storage System with Sunny Boy Storage are a Sunny Boy Storage, an SMA Energy Meter and a battery. The SMA Energy Meter can also be optionally replaced by the Sunny Home Manager 2.0. This enables intelligent energy management. The Sunny Boy Storage is a single-phase, AC coupled battery inverter for parallel grid operation.



Optimization of energy utilization

We assume a typical, single-family home with an annual PV generation of 5000 kWh, an annual energy demand of 5000 kWh, and a natural self-consumption of 30%. In this example, the SMA Flexible Storage System uses the available battery capacity of 5 kWh to optimize the energy balance as follows:

- Due to the significantly larger battery-storage system, the higher usable energy leads to an increase in the self-consumption quota from 30% to typically 65%.
- Accordingly, the purchased electricity amount decreases from 3500 kWh to 2150 kWh. The purchased electricity of 2150 kWh corresponds to 43% of the annual energy demand; this includes storage losses of 8%. The electricity bill is decreased by 38%.

3 Internal Power Supply and Self-Consumption with SMA Smart Home

3.1 Basic Solution for Intelligent Energy Management

Using the intelligent load control, the Sunny Home Manager uses its control options to shift the operation of flexible loads to times with high PV generation.

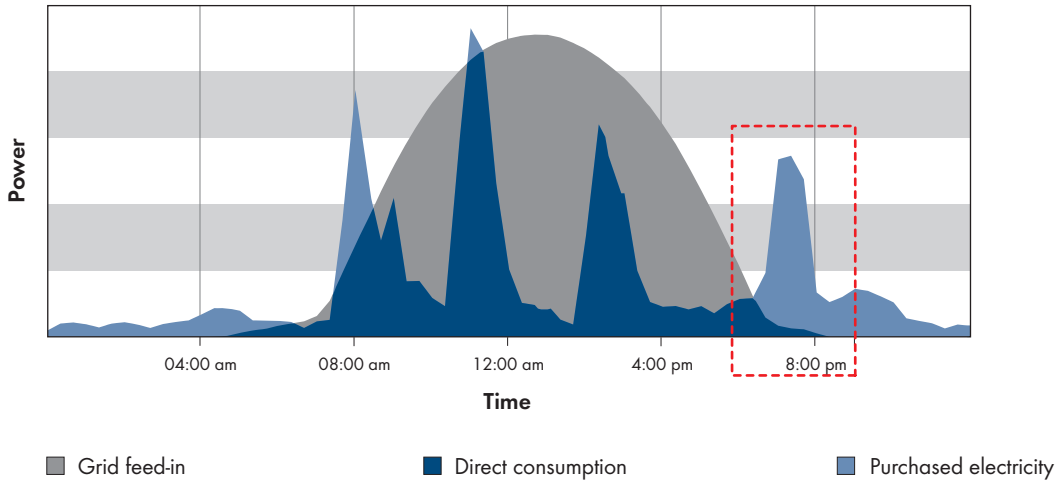

Figure 1: Daily profile of a PV system, consumption and self-consumption - without load control (example)

The red frame in this example shows a load peak in the evening. This load peak, for example, is caused by a washing machine that is switched on manually in the evening.

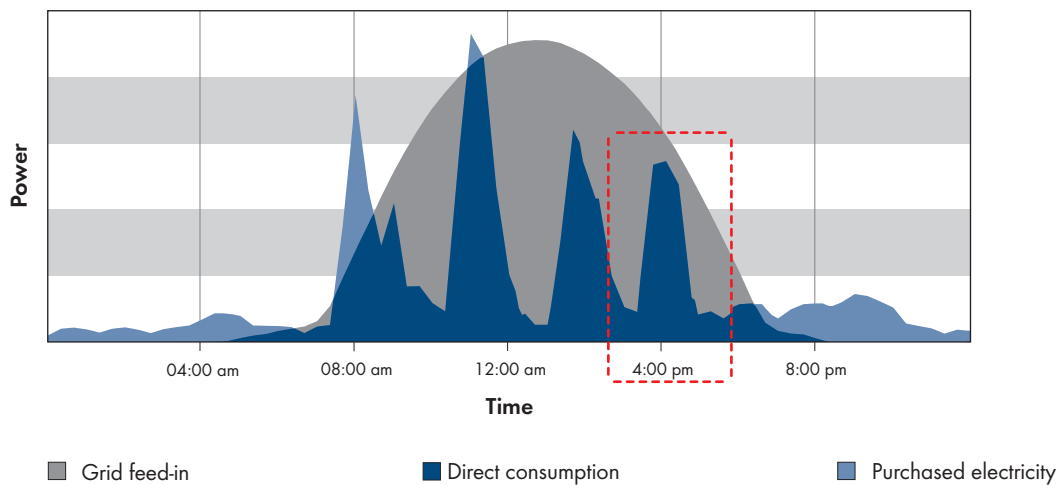

Figure 2: Daily profile of a PV system, consumption and self-consumption - with load control (example)

The red frame in this example shows the shifting of the load peak to the afternoon. Due to the automatic control by the energy management system, operation of the washing machine is shifted to a time period in which cheaper PV energy is available. PV self-consumption increases, lowering the energy costs for the user.

The Sunny Home Manager forms the core of the SMA basic solution for intelligent energy management.

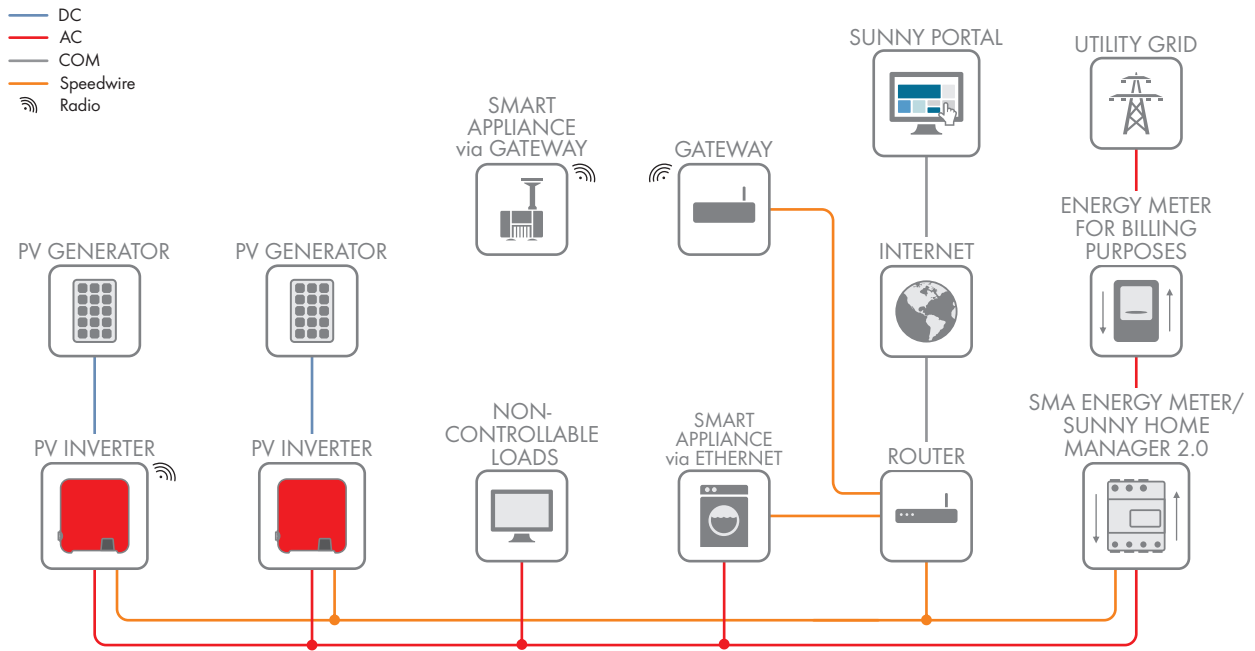

Figure 3: PV system with Sunny Home Manager (example)

The Sunny Home Manager offers the following energy management functions:

- Visualization of PV system data in Sunny Portal (see Section 4.1.2, page 19)
- Intelligent load control (see Section 4.1, page 19)
- Dynamic active power limitation (see Section 4.2, page 23)
- Zero Export (see Section 4.3.2, page 29)
- Access to grid management services via Modbus interface, e.g. for active power limitation by the grid operator

3.2 Simple Storage Solution for New PV Systems

The SMA Integrated Storage System is the simple storage solution for new PV systems. With the SMA Integrated Storage System, automatic load control and intermediate storage can be combined.

For intelligent use of the intermediate storage, the SMA Integrated Storage System takes the data from PV generation and consumption forecasts into account.

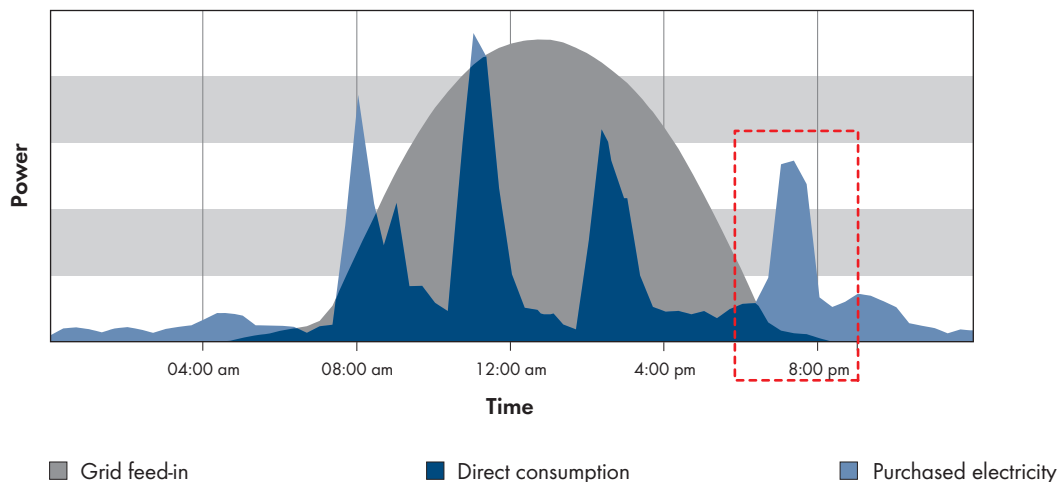

Figure 4: Daily profile of a PV system, consumption and self-consumption – without load control (example)

The red frame in this example shows a load peak in the evening. This load peak, for example, is caused by a washing machine that is switched on manually in the evening.

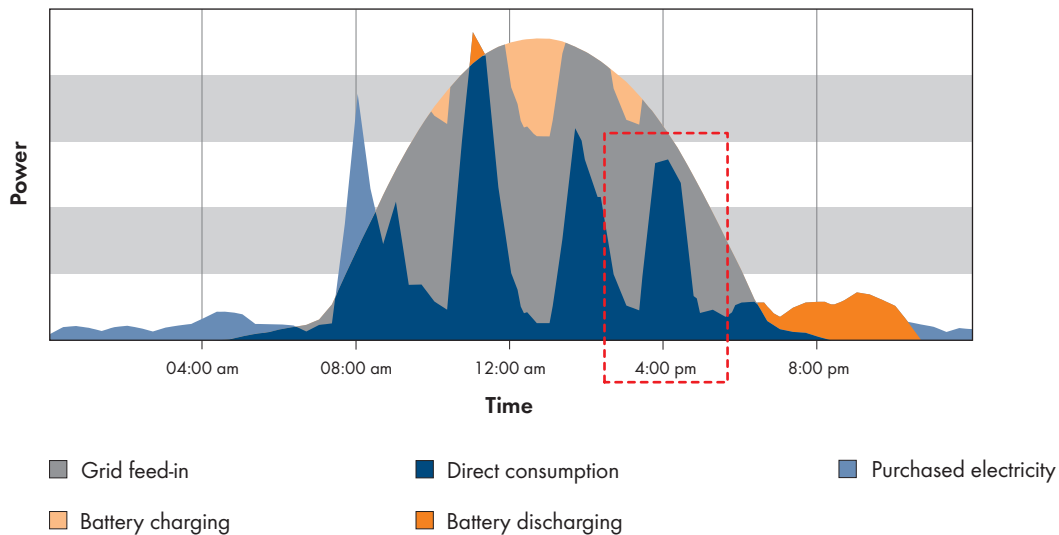
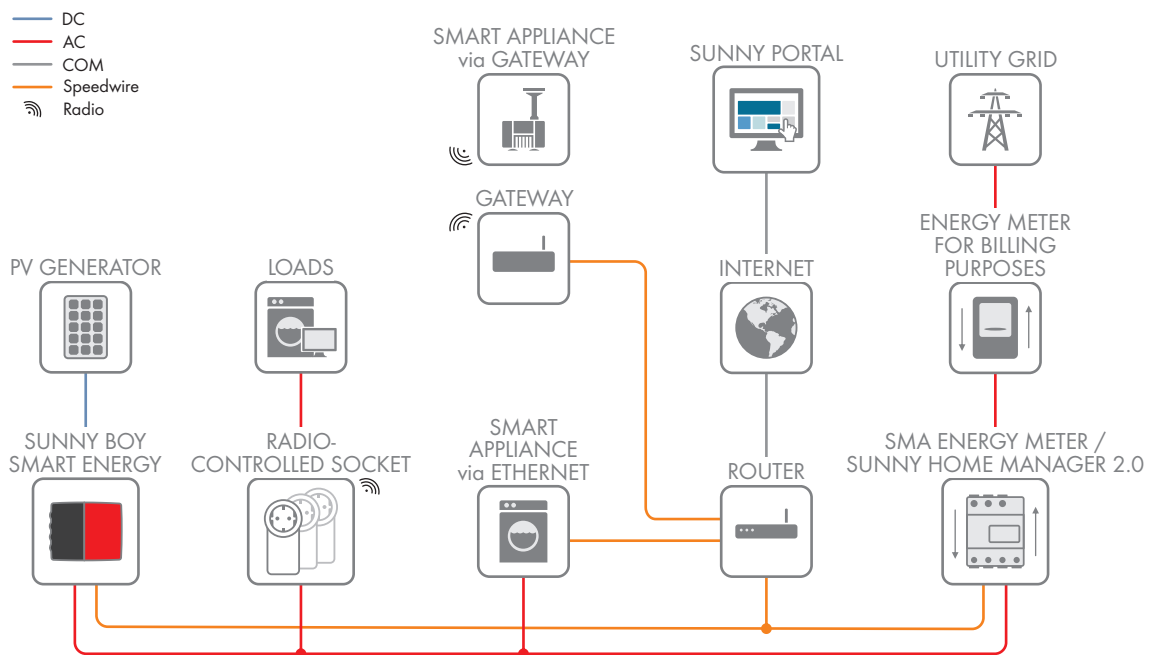

Figure 5: Daily profile of a PV system, consumption and self-consumption – with load control and intermediate storage (example for SMA Integrated Storage System)

In the morning at about 10:00 a.m. the battery is briefly charged with PV energy. This charged PV energy is used at around midday to cover a load peak. During the midday period when there is increased PV energy, the battery is charged again. In the evening, part of the load is supplied by battery discharging. In parallel, operation of a load is shifted to a time period with cheaper PV energy .



The most important elements of the SMA Integrated Storage System are the Sunny Boy 3600 / 5000 Smart Energy with integrated lithium-ion battery and the Sunny Home Manager. The integrated lithium-ion battery has a storage capacity of 2 kWh and enables optimally efficient operation in a typical, single-family house. Battery charging and discharging, among other things, are illustrated on the **Energy balance** page in Sunny Portal (see Section 4.1.2, page 19). This shows when the PV energy stored intermediately in the battery is consumed in the household, during the evening for example. Purchase of electricity can be avoided and the energy costs are decreased.

In order to be able to use the Sunny Boy Smart Energy on its own, at least an SMA Energy Meter is required additionally.

The Sunny Boy Smart Energy and the SMA Integrated Storage System offer the following energy management functions:

Functions	Sunny Boy Smart Energy	SMA Integrated Storage System
Visualization of PV system data in Sunny Portal (see Section 4.1.2, page 19)	✓	✓
Intelligent load control (see Section 4.1, page 19)	-	✓
Dynamic active power limitation (see Section 4.2.1, page 23)	✓	✓
Forecast-based charging (see Section 4.2.2, page 24)	✓	✓
Zero Export (see Section 4.3.2, page 29)	✓	✓
Automatic unbalanced load limitation (see Section 4.3.3, page 30)	✓	✓
Cumulative power control at the grid-connection point (see Section 4.3.4, page 31)	✓	✓
Access to grid management services via Modbus interface, e.g. for active power limitation by the grid operator	✓	✓

✓ Can be utilized - Can not be utilized

3.3 Flexible Storage Solution for New and Existing PV Systems

With the SMA Flexible Storage System, automatic load control and intermediate storage can be combined.

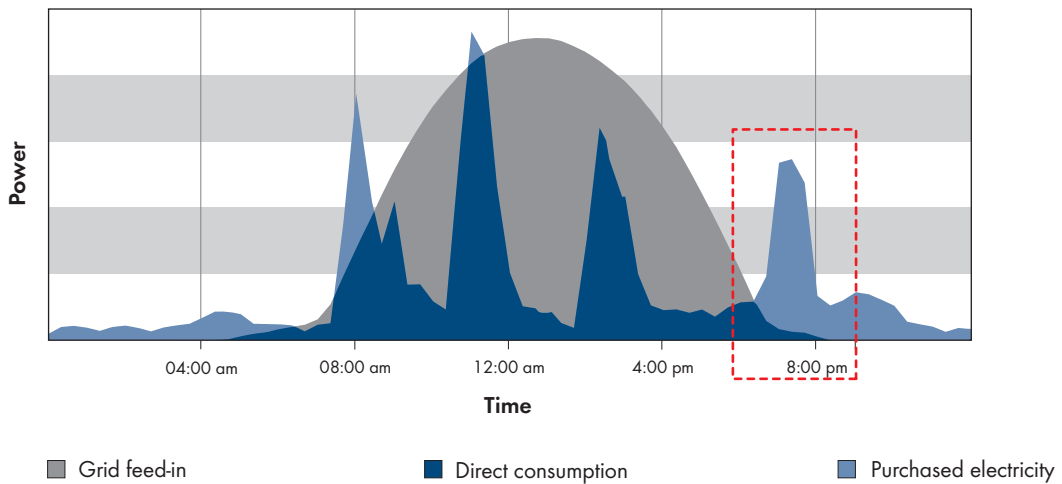

Figure 6: Daily profile of a PV system, consumption and self-consumption - without load control (example)

The red frame in this example shows a load peak in the evening. This load peak, for example, is caused by a washing machine that is switched on manually in the evening.

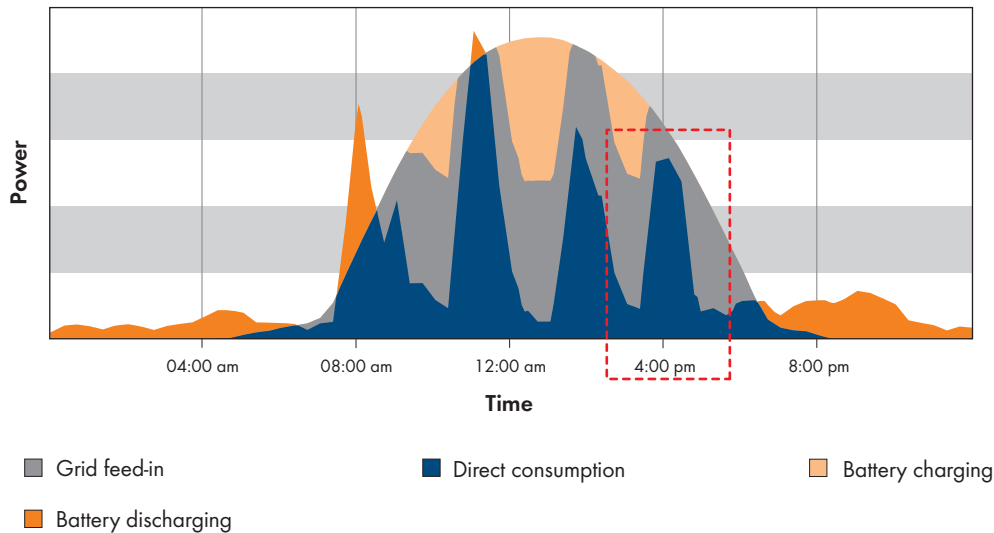

Figure 7: Daily profile of a PV system, consumption and self-consumption – with load control and intermediate storage (example for SMA Flexible Storage System)

Due to the greater battery capacity in the SMA Flexible Storage System, a greater portion of consumption can be covered by intermediate storage. In this example, the coverage is 100%. This means that there is no longer a requirement for purchased electricity.

By way of the Energy balance page in Sunny Portal, an overview of the energy consumption in the house, energy generation by the PV system and the feeding in of excess PV energy into the utility grid is available at all times. The charging and discharging of any available battery is also visualized. This shows when the PV energy stored intermediately in the battery is consumed in the household, during the evening for example. Purchase of electricity can be avoided and the energy costs are decreased.

The SMA Flexible Storage System is a flexible storage solution to enhance new and existing PV systems in the context of intelligent energy management. The SMA Flexible Storage System can be installed with the Sunny Island or the Sunny Boy Storage.

SMA Flexible Storage System with Sunny Island

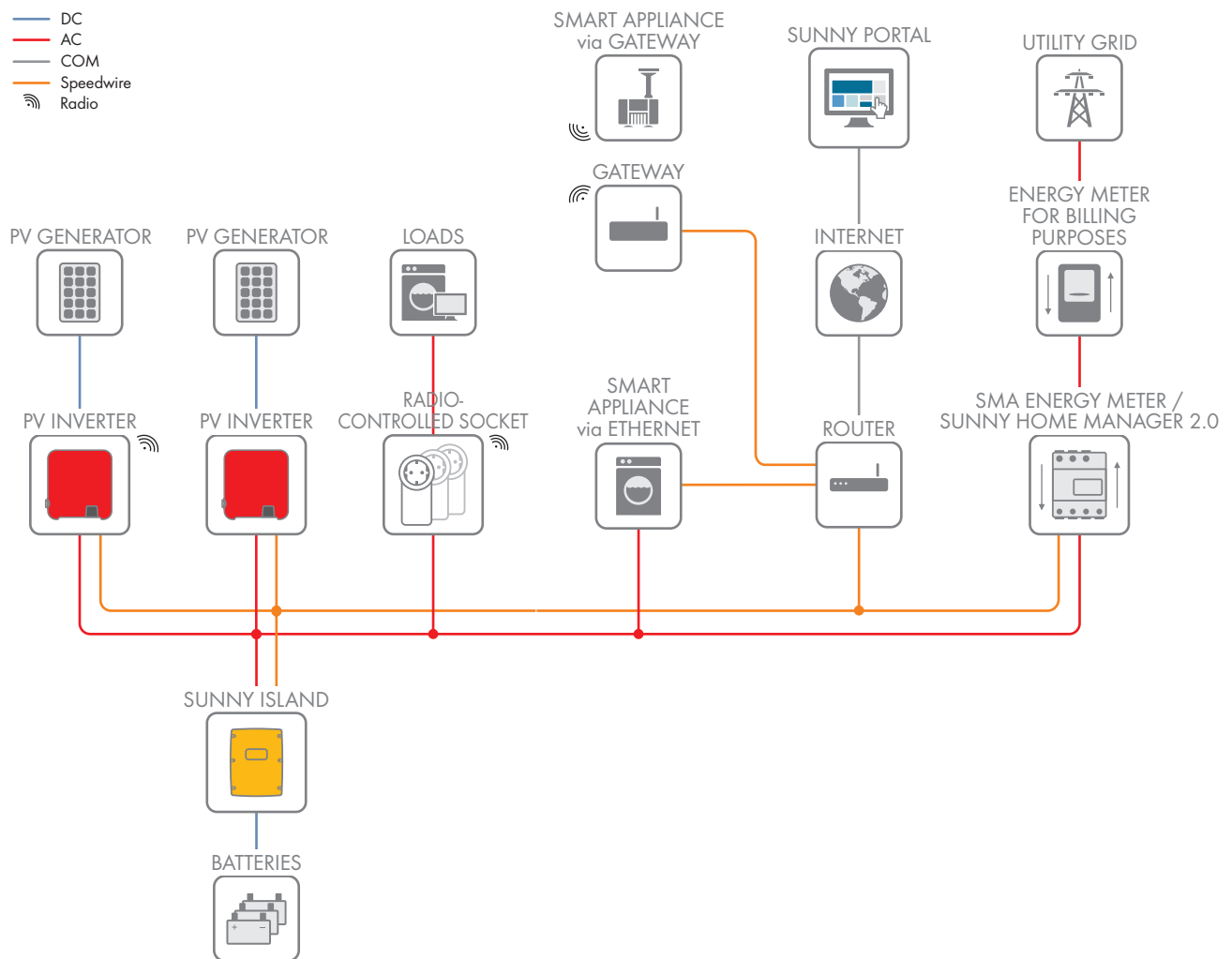

Figure 8: PV system with SMA Flexible Storage System with Sunny Island (example)

At the core of the SMA Flexible Storage System with Sunny Island is the Sunny Island 4.4M / 6.0H / 8.0H. The Sunny Island can use different battery types with different battery capacities and thus, with regard to system design, offers great flexibility. Also, in the SMA Flexible Storage System, different SMA PV inverters can be used.

Together with a battery and the SMA Energy Meter, the Sunny Island becomes an SMA Flexible Storage System. The SMA Energy Meter can also be optionally replaced by the Sunny Home Manager 2.0. This enables intelligent energy management.

When using the Sunny Island inverter, the SMA Flexible Storage System can be set up as single-phase and three-phase and can be extended with a battery-backup function. The SMA Flexible Storage System with battery-backup function supplies the loads with electricity in the event of a grid failure and also forms a battery-backup grid (see the Planning Guidelines "SMA FLEXIBLE STORAGE SYSTEM with Battery-Backup Function" at www.SMA-Solar.com).

The SMA Flexible Storage System with Sunny Island offers the functions listed in the following table depending on the expansion stage.

Functions	Sunny Island*	Sunny Island with Sunny Home Manager	Sunny Island with Sunny Home Manager and additional energy meter for PV production
Visualization of PV system data in Sunny Portal (see Section 4.1.2, page 19)	✓	✓	✓
Intelligent load control (see Section 4.1, page 19)	-	✓	✓
Dynamic active power limitation (see Section 4.2.1, page 23)	✓	✓	-
Forecast-based charging (see Section 4.2.2, page 24)	-	✓	✓
Zero Export (see Section 4.3.2, page 29)	✓	✓	-
Automatic unbalanced load limitation (see Section 4.3.3, page 30)	✓	✓	✓
Cumulative power control at the grid-connection point (see Section 4.3.4, page 31)	✓	✓	✓
Access to grid management services via Modbus interface, e.g. for active power limitation by the grid operator	✓	✓	✓**
Support for PV inverters by third-party providers (see Section 6.3.3, page 43)	-	-	✓**

* To be able to only use the Sunny Island for increased self-consumption, only the device types SI4.4-M12, SI6.0H-12 and SI8.0H-12 may be used. In this case, an SMA Energy Meter must be used for recording measured values.

** When using PV inverters from third-party providers, it must be ensured that the grid operator can access the required grid management services via the interfaces or user interfaces of the third-party provider.

✓ Can be utilized - Can not be utilized

SMA Flexible Storage System with Sunny Boy Storage

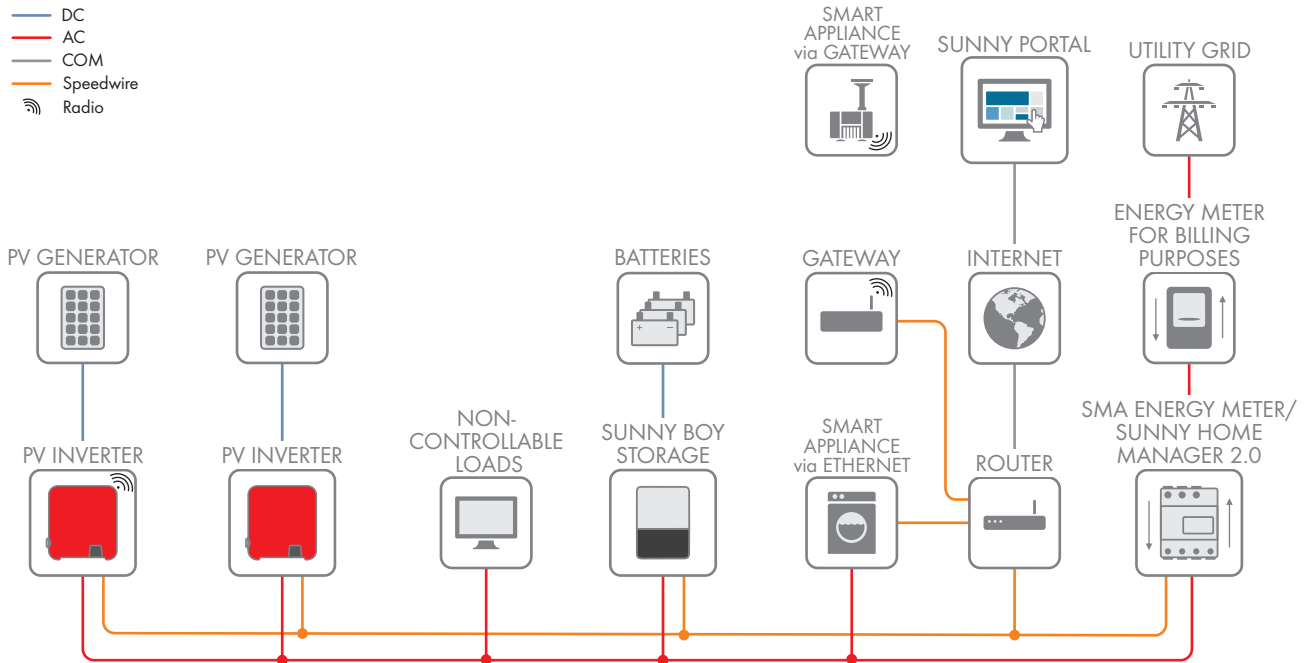

Figure 9: PV system with SMA Flexible Storage System with Sunny Boy Storage (example)

At the core of the SMA Flexible Storage System with Sunny Boy Storage is the Sunny Boy Storage 2.5 / 3.7 / 5.0 / 6.0. The Sunny Boy Storage is a single-phase, AC coupled battery inverter for parallel grid operation. The Sunny Boy Storage converts the direct current supplied by a battery into grid-compliant alternating current. With a lithium-ion battery and the SMA Energy Meter, the Sunny Boy Storage becomes an SMA Flexible Storage System.

The SMA Energy Meter can also be optionally replaced by the Sunny Home Manager 2.0. This enables intelligent energy management.

The SMA Flexible Storage System with Sunny Boy Storage offers the functions listed in the following table depending on the expansion stage.

Functions	Sunny Boy Storage*	Sunny Boy Storage with Sunny Home Manager	Sunny Boy Storage with Sunny Home Manager and additional energy meter for PV production
Visualization of PV system data in Sunny Portal (see Section 4.1.2, page 19)	✓	✓	✓
Intelligent load control (see Section 4.1, page 19)	-	✓	✓
Dynamic active power limitation (see Section 4.2.1, page 23)	✓	✓	-

Functions	Sunny Boy Storage*	Sunny Boy Storage with Sunny Home Manager	Sunny Boy Storage with Sunny Home Manager and additional energy meter for PV production
Forecast-based charging (see Section 4.2.2, page 24)	-	✓	✓
Zero Export (see Section 4.3.2, page 29)	✓	✓	-
Automatic unbalanced load limitation (see Section 4.3.3, page 30)	✓	✓	✓
Cumulative power control at the grid-connection point (see Section 4.3.4, page 31)	✓	✓	✓
Access to grid management services via Modbus interface, e.g. for active power limitation by the grid operator	✓	✓	✓**
Support for PV inverters by third-party providers (see Section 6.3.3, page 43)	-	-	✓**

* The use of an SMA Energy Meter is recommended for recording measured values.

** When using PV inverters from third-party providers, it must be ensured that the grid operator can access the required grid management services via the interfaces or user interfaces of the third-party provider.

✓ Can be utilized - Can not be utilized

4 Functions for Energy Management Systems

4.1 Load Control

4.1.1 Energy Monitoring - Measuring and Understanding Energy Flows

The household makes use of electrical energy in different ways. To enable effective energy management, therefore, it is necessary to understand in detail the energy flows in the household.

In an SMA Smart Home, energy consumption can be measured at various points:

- The integrated measuring device of the Sunny Home Manager 2.0 and SMA Energy Meter at the grid-connection point provides the electrical measured values for PV generation, for grid feed-in, and for purchased electricity as a cumulative value across the phases for the entire household.
- Using the available radio-controlled sockets, the Sunny Home Manager can individually measure and monitor the energy consumption of specific loads. The more loads that are monitored in this way, the more complete is the energy consumption data basis of the household.

The Sunny Home Manager collects all the information on the energy flows and makes it available for evaluation via Sunny Portal in various diagram displays.

The information can be used to answer the following questions, for example:

- What is the energy consumption of the household?
- How much energy is supplied by the PV system?
- How much energy is required by selected loads?
- How often and for how long are these loads in operation?

Answering these questions will enable you to analyze and understand the energy flows in the household, e.g.:

- Which loads require the most energy?
- Which loads possibly require too much energy and should be replaced by more energy-efficient models?
- Which usage habits for loads should possibly be changed in order to use PV energy more effectively?
- What effect would switching to a different electricity tariff have on the energy costs?

Using this knowledge, energy management measures can be defined. These measures can lead to savings in energy costs and also help to protect the environment. For automatic load control, these findings provide guidelines on when it is most efficient to switch on certain loads.

4.1.2 Visualization of PV System Data in Sunny Portal

Sunny Portal offers various functions for visualizing and controlling the energy flows in the household:

- By way of the **Energy balance** page in Sunny Portal, an overview of the energy consumption in the house, energy generation by the PV system and the feeding in of excess PV energy into the utility grid is available at all times. The charging and discharging of any available battery is also visualized. Depending on the time period selected, values from the past can also be displayed.
As a result of the forecasts determined for PV generation and consumption, information on manual load control is provided which can increase self-consumption.
- The page **Load balance and control** shows the energy consumption, energy mix and the time of operation for selected loads. You can select various time periods and views in the overview.
- Selected loads can be time-controlled in such a way that primarily PV energy is consumed or energy is allocated at optimum cost. As a result of the PV generation forecast available and the consumption behavior experienced, an optimum increase in self-consumption can be achieved (see Section 4.1.4, page 21).
- System status information can be used to monitor the proper operation of the PV system.

4.1.3 Components of Load Control

In the SMA Smart Home, radio-controlled sockets can be used to control home appliances and they enable optimization of energy consumption and the self-consumption quota through load shifting. The radio-controlled sockets also measure the power consumption of the connected loads and thus enable energy monitoring.

Compatible radio-controlled sockets for the SMA Smart Home are:

- WLAN Edimax SP-2101W radio-controlled socket (available via the online shop)

WLAN Edimax SP-2101W radio-controlled socket

As an adapter for a load, the WLAN Edimax SP-210W radio-controlled socket can switch on the power supply or interrupt it. It also measures the power that the load requires for operation.

Radio-controlled sockets are registered via a special Edimax app at the local router. With this, they can be controlled by the Sunny Home Manager 2.0 via the WLAN connection.

Information: Only the WLAN Edimax SP-2101W radio-controlled socket is compatible with the Sunny Home Manager 2.0. Other radio-controlled sockets from Edimax that can only switch are therefore unable to work with the Sunny Home Manager 2.0.

Bearing in mind the compatibility of the WLAN Edimax SP-2101W radio-controlled socket with the Sunny Home Manager 2.0, observe the following regarding the firmware version of the devices:

- Sunny Home Manager 2.0 firmware from version 2.0.6.R
- The WLAN Edimax SP-2101W radio-controlled socket up to firmware version 2.08
- The WLAN Edimax SP-2101W V2 radio-controlled socket from firmware version 1.00

4.1.4 Mode of Operation of Load Control

Using various displays and settings in the system pages of Sunny Portal, you can display current information, e.g. status information, energy balances, and forecasts for PV generation and for specific electrical consumption in the household. From these, the Sunny Home Manager derives action recommendations and uses these recommendations to control the loads.

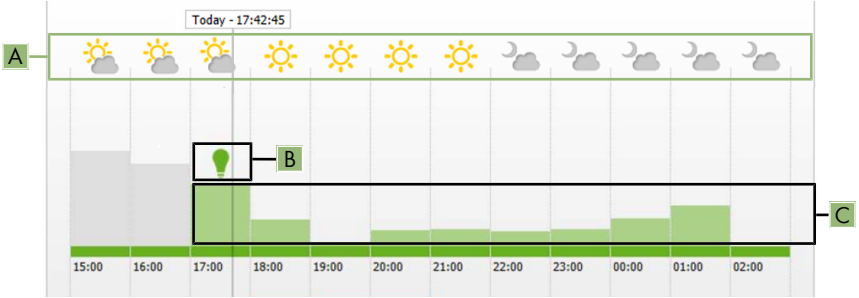
Function	Explanation
Creation of a PV yield forecast	<p>The Sunny Home Manager continuously logs the energy generated by the PV system. The Sunny Home Manager also receives location-based weather forecasts via the Internet. Based on this information, the Sunny Home Manager creates a PV yield forecast for the PV system.</p> <p>To query forecast information, you must fill in the following input fields on the System properties page in Sunny Portal:</p> <ul style="list-style-type: none"> • Longitude • Latitude • Nominal system power <p>If one of the three entries is missing, either the weather symbols are not displayed, the power forecast is not present, or it is incorrect.</p> 
Creation of a load profile	<p>The Sunny Home Manager logs data on PV generation, grid feed-in and purchased electricity. Based on PV generation, grid feed-in and purchased electricity, the Sunny Home Manager determines how much energy is typically consumed at certain times and uses this to create a load profile for the household. This load profile can be different for each day of the week.</p> <p>The Sunny Home Manager receives the measured data for PV generation, grid feed-in and purchased electricity via the installed energy meters (SO, DO or SMA Energy Meter) or from the inverters directly via the data connection.</p>

Function	Explanation
Configuration and system monitoring via Sunny Portal	<p>Sunny Portal serves as the user interface of the Sunny Home Manager. The Sunny Home Manager establishes the Internet connection to Sunny Portal via a router and sends the read-out data to Sunny Portal. The user can make all the required settings for the Sunny Home Manager system via Sunny Portal.</p> <p>You can call up data on energy consumption and generation and also forecasts and information on energy use via diagrams and tables. In addition, basic PV system monitoring is also possible via Sunny Portal.</p>
Load control via radio-controlled sockets	<p>Specific loads connected to radio-controlled sockets can be switched on and off by the Sunny Home Manager. The Sunny Home Manager uses the yield forecast and the load profile to determine favorable time periods for optimization of internal power supply and self-consumption. In accordance with the PV system operator's specifications and taking the determined time periods into account, the Sunny Home Manager controls the switching on and -off of the loads.</p> <p>Furthermore, radio-controlled sockets provide the option of individually monitoring and recording the energy consumption of loads.</p>
Preventing Derating Losses	<p>The Sunny Home Manager can also use intelligent energy management to ensure that loads in the household are switched on at precisely those times when so much PV energy is available that the feed-in limit would be reached. If switching on a load means that more power is consumed directly in the household, then the PV generation must not be reduced by as much or must not be reduced at all.</p> <p>When used with SMA battery inverters, the intermediate storage can be used additionally to prevent derating losses. Taking the PV yield forecast and the consumption forecast into account, the timing and duration of battery charging are controlled and the battery charge is optimized according to the available energy supply, if excess PV energy cannot otherwise be used.</p>

4.1.5 Application Examples

The following application examples of load control in SMA Smart Home are available in the download area of the Sunny Home Manager at www.SMA-Solar.com:

- "SMA SMART HOME - Load Control via MUST Time Period - Example: Washing Machine"
- "SMA SMART HOME - Load Control via CAN Time Period - Example: Pool Pump"
- "SMA SMART HOME Load Control Using Relays or Contactors - Example: Heating Rod"
- "SMA SMART HOME - Home appliance energy management using EEBus"
- "SMA SMART HOME - Battery Charging Management with Time-of-Use Energy Tariffs"

4.1.6 Distinguishing Between Self-Consumption Systems and Feed-In Systems in SMA Smart Home

In the system properties in Sunny Portal, you can set the system type for the relevant system. There are two system types:

- Self-consumption system
- Feed-in system

Self-consumption system

The objective in a self-consumption system is to consume as much of the generated PV energy oneself as possible. This works best if the loads in the household are switched on whenever the sun is shining and the PV system is generating a lot of electricity.

The Sunny Home Manager uses its intelligent energy management to ensure that the controllable loads are switched on automatically when there is sufficient PV energy available.

Self-consumption systems are attractive whenever the feed-in tariff for PV energy is significantly below the purchase cost of grid current. Therefore, high self-consumption contributes to lowering the energy costs.

The energy meters must be installed in such a way that the household loads can consume the PV energy before the feed-in or grid-connection point. Then only the surplus PV energy is fed into the utility grid.

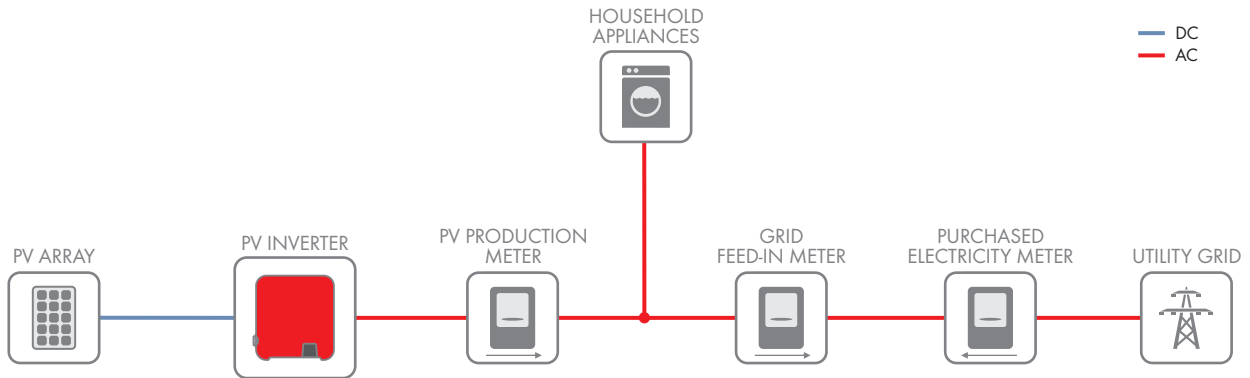

Figure 10: Energy meter installation in a self-consumption system (example)

Feed-in system

The objective of a feed-in system is to feed all the generated PV energy into the utility grid in order to receive the relevant feed-in tariff.

Feeding in of generated PV energy is attractive whenever the feed-in tariff is significantly above the purchase cost of grid current. In this case, the grid feed-in of PV energy is an attractive source of income for the PV system operator. Energy management for such systems is of limited value.

The energy meter must be installed in such a way that the household loads do not consume the PV energy directly:

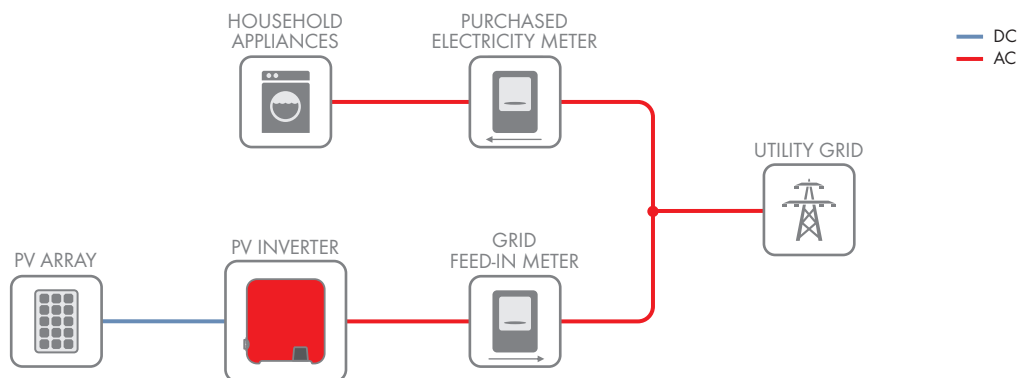

Figure 11: Energy meter installation in a feed-in system (example)

i Restriction with feed-in systems with Sunny Home Manager

In feed-in systems with Sunny Home Manager, you cannot configure a CAN time period in Sunny Portal for load control.

4.2 Dynamic Limitation of Active Power Feed-In to Avoid Derating Losses

4.2.1 General information regarding the limitation of active power feed-in

Local regulations, for example the Renewable Energy Sources Act (EEG) in Germany, can call for permanent limitation of active power feed-in for your PV system - that is, a limitation of the active power fed into the utility grid to a fixed amount or a percentage share of the installed nominal PV system power. Ask your grid operator, if required, whether a permanent limitation of active power feed-in is necessary.

For the limitation of active power feed-in, the active power that is fed into the utility grid is monitored via the integrated measuring device of the SMA Home Manager or SMA Energy Meter. The amount of active power fed in depends on the current PV generation and on the consumption in the household. However, it can be affected by the charging of a battery. If the active power feed-in exceeds a prescribed threshold, the Sunny Home Manager will limit the PV generation of the inverters.

Use of the Sunny Home Manager to Limit Active Power Feed-In

In addition to the dynamic limitation of PV generation, the Sunny Home Manager can also use intelligent energy management to ensure that loads in the household are switched on at precisely those times when so much PV energy is available that the feed-in limit would be reached. If switching on a load means that more power is consumed directly in the household, then the PV generation must not be reduced by as much or must not be reduced at all.



Limitation of the active power feed-in to 70% of the nominal PV system power

Due to high levels of solar irradiation, the system can currently produce 90% of the nominal PV system power.

- 20% of the nominal PV system power is currently being consumed by loads in the household. The remaining amount of 70% of the nominal PV system power is being fed into the utility grid.
 - No limitation of PV generation is required.
- A load is switched off and only 10% of the nominal PV system power is consumed in the household. As a result, 80% of the nominal system power is available for feed-in to the utility grid – more than allowed.
 - The Sunny Home Manager reduces PV generation from the theoretically possible 90% of nominal PV system power to 80%. 70% of the nominal PV system power continues to be fed into the utility grid.

The Sunny Home Manager can be used alone or as part of a storage solution for limitation of active power feed-in.

From firmware version 1.13.xx.R, the Sunny Home Manager enables the limitation of active power feed-in to 0% or 0 W. This "Zero Export" mode can also be used for storage solutions (see Section 4.3.2, page 29).

4.2.2 Avoiding Derating Losses Through Forecast-Based Battery Charging in SMA Storage Solutions

On days with strong sunshine around noon, a large portion of the available PV power may have to be derated to limit the active power feed-in due to local requirements. The Sunny Home Manager energy management already ensures that, especially on such days the controllable loads in the household are switched on exactly at those times in order to consume the energy that would otherwise be derated.

In addition, the energy from the noon peak can also be stored in the battery of the battery inverter. This is particularly effective since the stored energy can then be used when required at a later time.

Battery inverters draw power to charge the battery from a surplus of generated PV energy. This means that, before PV energy is fed into the utility grid, the system first attempts to use the energy to charge the battery. On days with strong sunshine, there may be a surplus of PV energy in the morning and the battery may even be fully charged before the noon peak. In this case, limitation of the PV feed-in is necessary at noon as the battery can no longer use the surplus PV energy.

This curtailment is avoided during forecast-based battery charging. Based on a PV power generation forecast and load planning, it is being forecast whether derating losses are expected at noon of the following day due to the limitation of PV feed-in. Already in the afternoon of the current day or in the morning of the next day, only the amount of energy is fed into the battery to absorb the forecast derating losses with the remaining battery capacity. This way, sufficient battery capacity will remain for the noon period so that the energy, which would otherwise be derated, can be charged to the battery.

SMA Flexible Storage System with Sunny Island and Sunny Boy Storage

In Sunny Portal, in the device properties of the Sunny Home Manager, you can activate the optimized storage management for the Sunny Island or Sunny Boy Storage. This setting is deactivated by default. When the forecast-based battery charging is activated, the Sunny Home Manager can ensure a forecast-based battery charge through activation of the battery inverter (see Section 4.2.3 "Example of Avoiding Derating Losses with Forecast-Based Battery Charging", page 28).

SMA Integrated Storage System

In accordance with the setting for active power feed-in limitation, optimization of the 2 kWh battery-storage system is always activated in the SMA Integrated Storage System. Both with and without the Sunny Home Manager, an inverter-internal generated forecast regarding a probable curtailment during the noon peak brings about delayed charging of the battery during the morning. If the active power feed-in limitation is set to 100%, this optimization is practically deactivated.

Examples of power control with the SMA Integrated Storage System and the SMA Flexible Storage System

Below, the power control of the SMA Integrated Storage System and the SMA Flexible Storage System is illustrated by way of examples from Sunny Portal.

Example 1: Avoiding derating losses through forecast-dependent charging

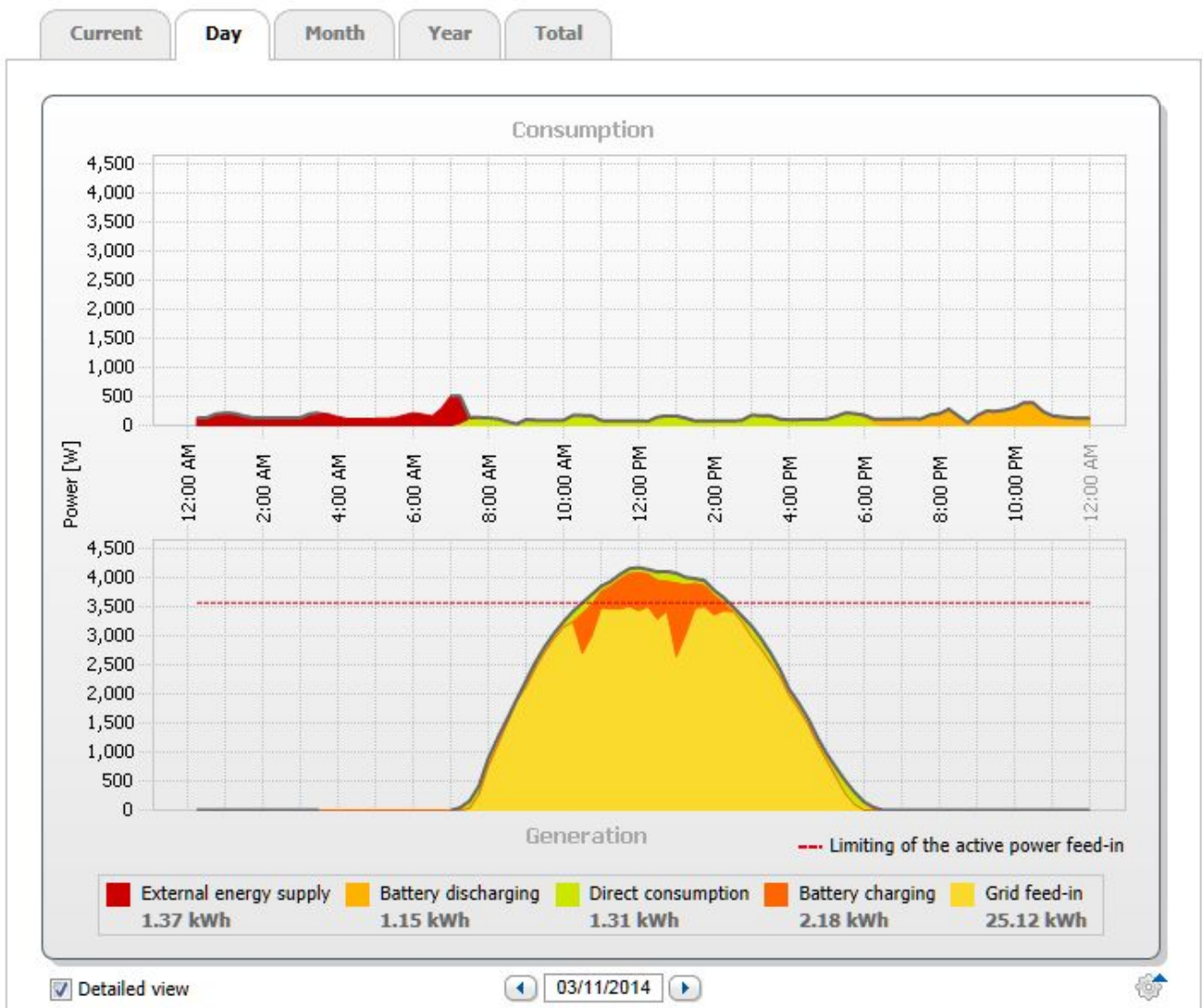

Figure 12: Consideration of PV generation and consumption in Sunny Portal (example 1)

The current daily forecast of the system predicts a limitation of active power feed-in around noon when the energy requirement of the loads is very low and PV production is high. For this reason, derating losses can be expected. According to this forecast, the system only begins to charge the battery in the late morning. The derating losses are almost completely avoided through battery charging.

Example 2: Avoiding derating losses through direct consumption and battery charging

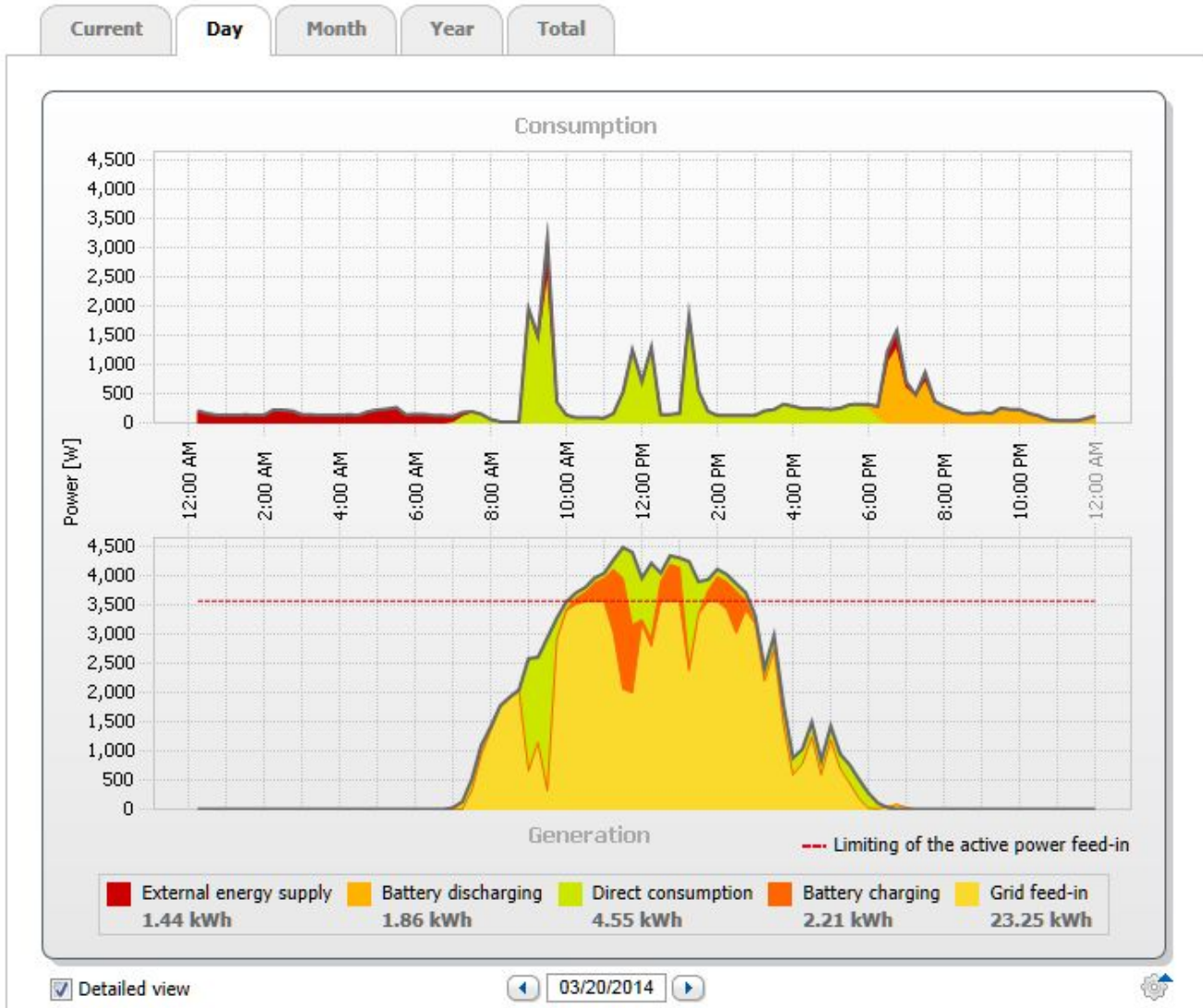

Figure 13: Consideration of PV generation and consumption in Sunny Portal (example 2)

As in example 1, the current daily forecast anticipates limitation of the active power feed-in around noon. In this case, however, the loads have a slightly higher energy demand. To avoid derating losses, therefore, the SMA Integrated Storage System / SMA Flexible Storage System schedules direct consumption and intermediate storage for the midday period.

According to its forecast, the system only begins to charge the battery in the late morning. The derating losses are avoided through direct consumption and battery charging.

Example 3: Avoiding derating losses through direct consumption

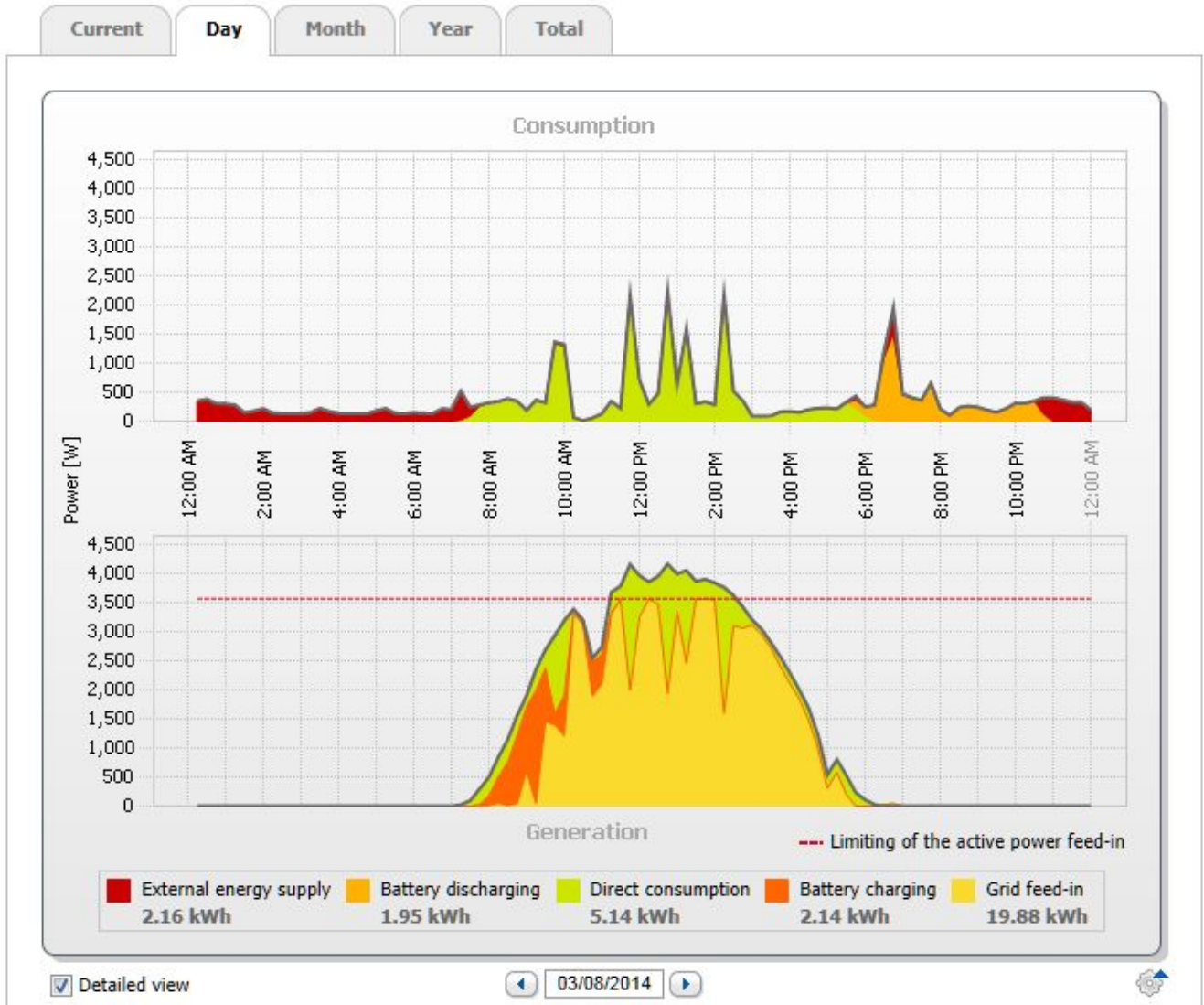

Figure 14: Consideration of PV generation and consumption in Sunny Portal (example 3)

As in examples 1 and 2, the current daily forecast anticipates limitation of the active power feed-in around noon. In this case, however, the loads have a much higher energy demand. The expected derating losses are therefore avoided completely through direct consumption.

The system, therefore, fully charges the battery during the morning and, in this example, avoids derating losses exclusively through direct consumption, for example, through intelligent load control.

Example 4: No forecast for derating losses

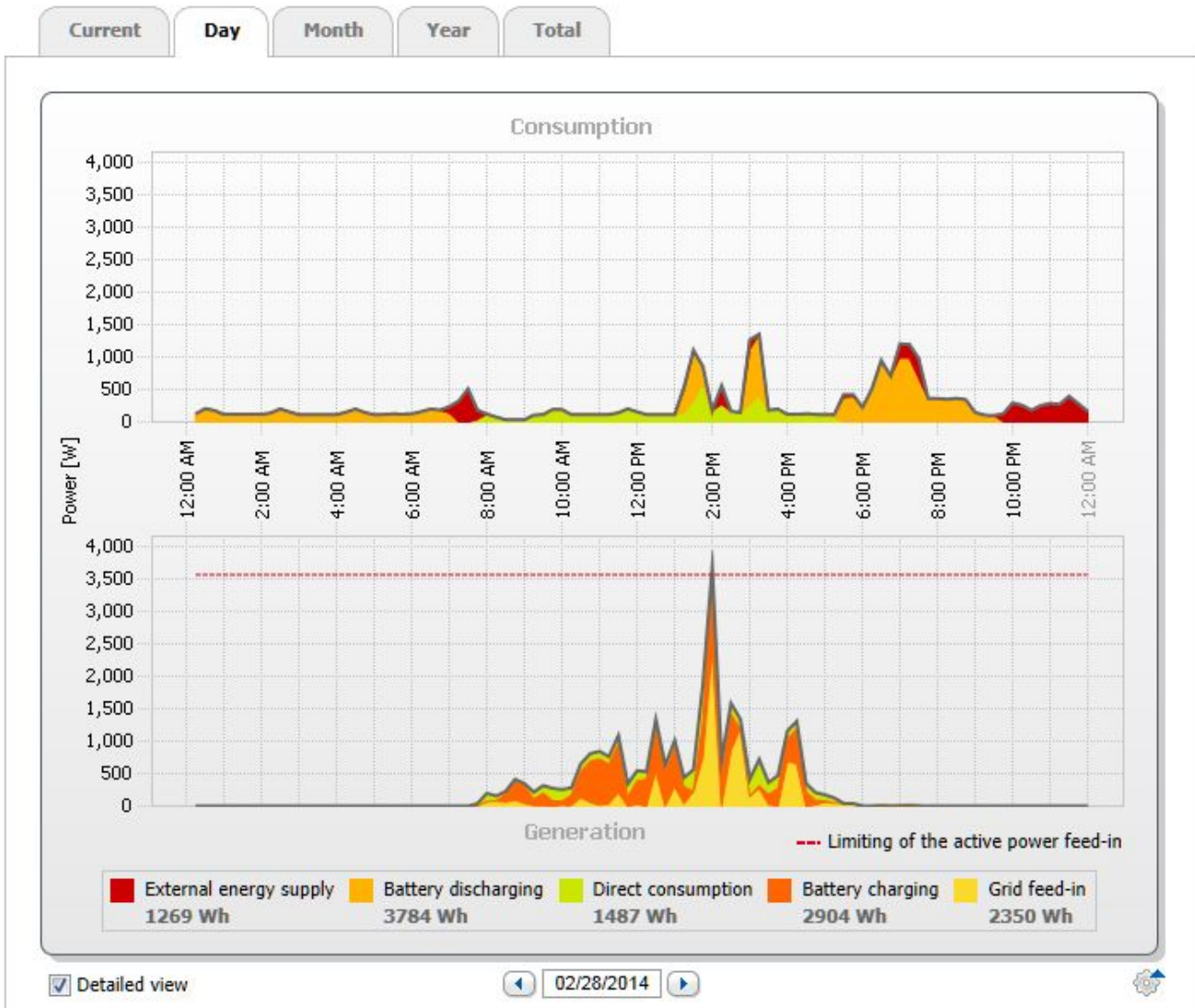

Figure 15: Consideration of PV generation and consumption in Sunny Portal (example 4)

If no limitation of active power feed-in is forecast for the current day, the SMA Integrated Storage System works in accordance with the general power control (see Section 4.3.1, page 29).

4.2.3 Example of Avoiding Derating Losses with Forecast-Based Battery Charging

With the SMA Flexible Storage System, you can choose between an economically optimized mode of operation (activation of the forecast-based battery charging) and an optimized mode of operation with regard to the self-sufficiency (no activation of the forecast-based battery charging).

The advantages and disadvantages of forecast-based battery charging using an example are considered in this Section. We assume a limitation of the feed-in power of 60%.

Input data:

- Peak power of the PV system: 5000 Wp
- Annual energy demand: 5000 kWh
- Total battery capacity: 10000 Wh, of which the Sunny Island uses 50% for intermediate storage of the PV energy.

The usable battery capacity therefore amounts to 5000 Wh.

The following figure illustrates the percentage derating losses with and without forecast-based battery charging:

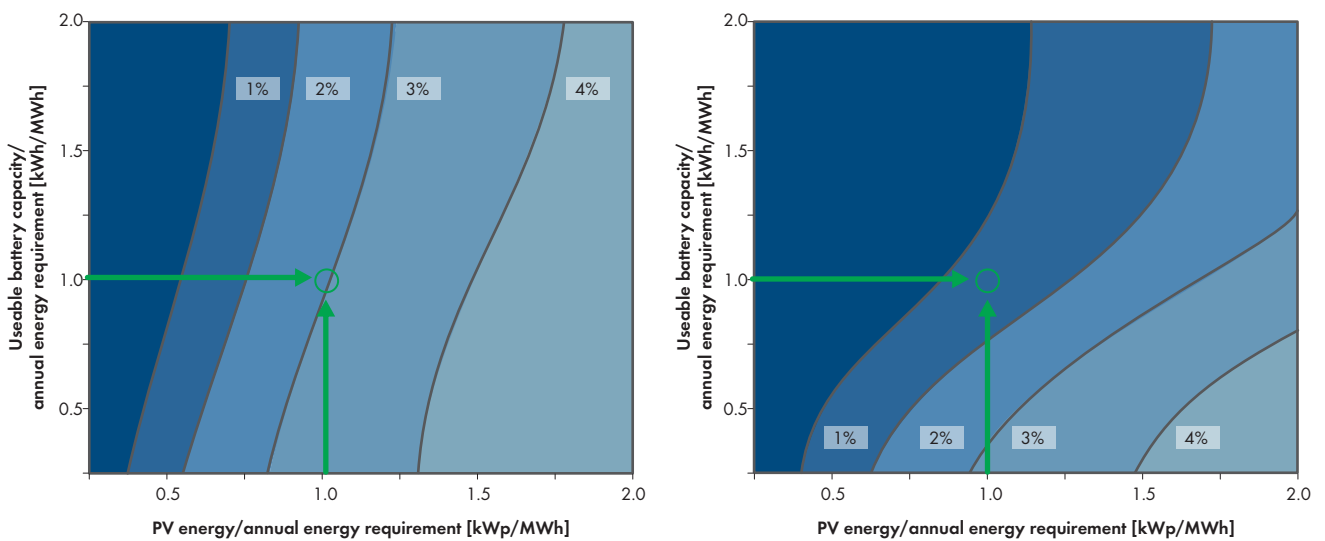

Figure 16: Annual percentage losses based on the PV generation with limitation of grid feed-in to 60% – without (A) and with (B) forecast-based battery charging

If we assume a PV generation of 4500 kWh per year for a PV system with a power of 5 kWp, we see the following results:

- With fixed active power feed-in limitation, 315 kWh of the generated PV energy is derated – this equals 7% of 4500 kWh (the value of 7% applies for all configurations)
- Without forecast-based battery charging, 135 kWh of the generated PV energy is derated - this equals 3% of 4500 kWh (see part A in the figure above)
- With forecast-based battery charging, only 67 kWh of the generated PV energy is derated - this equals 1.5% of 4500 kWh (see part B in the figure above)

Through forecast-based battery charging, we could thus intermediately store 68 kWh of PV energy (135 kWh – 67 kWh) in the battery and use it to supply the household instead of having it derated. By shifting the charging operation from morning to noon, the PV system could also feed in more during the morning.

Conclusion:

If we compare the options with and without forecast-based battery charging, the forecast-based battery charging results in a positive financial effect in most cases. However, it is possible that the forecasts are not correct. As a result, the battery may be used less which can lead to lower self-sufficiency quotas.

4.3 Power Control at the Grid-Connection Point

4.3.1 General Power Control

In the interests of the highest possible internal power supply and the highest possible self-consumption, the power control at the grid-connection point has the following objectives:

- Before the PV system feeds into the utility grid, this electrical energy should be consumed directly or stored intermediately in a battery.
- Before the loads draw energy from the utility grid, this energy should be provided by the PV system or by discharging the battery.

The energy management system achieves these objectives taking the forecast for PV generation and electricity consumption for the current day into account.

4.3.2 Limitation of Active Power Feed-In to 0% or 0 W

Some grid operators permit connection of PV systems only on condition that no active power is fed into the utility grid. The PV energy is therefore consumed exclusively at the place where it is generated.

During the limitation of active power feed-in to 0% or 0 W, it must be ensured that the active power currently generated by the PV inverters is controlled in such a way that it equals the power currently being consumed in the household. If, in this situation, an active load in the household is switched off, the inevitable active power feed-in will be reduced to a value less than 2% of nominal PV system power within a reaction time of 1.5 to 2.5 seconds. This means that PV systems can be created with 100% self-consumption.

The following products enable the limitation of the active power feed-in to 0% or 0 :

- Sunny Home Manager from firmware version 1.11.4.R
From firmware version 1.13.X.R of the Sunny Home Manager, battery inverters are fully supported (exception: SMA Integrated Storage System is not supported).
- Sunny Boy Storage 2.5 from firmware version 02.02.01.R
- Sunny Boy Storage 3.7 / 5.0 / 6.0
- Sunny Island of the device type SI4.4-12 / SI6.0H-12 / SI8.0H-12

For that, the following requirements must be met when installing the PV system:

- In the event of an interruption of the communication for system control, the PV inverters must be capable of limiting their active power feed-in to a predefined value (see PV inverter documentation).
- A Sunny Home Manager 2.0 or an SMA Energy Meter must be used to measure grid purchase and grid feed-in power levels at the grid-connection point.
- Configuration of the active power limitation settings to 0% must be done by a qualified person.

4.3.3 Avoiding Unbalanced Load

Requirements of the "VDE Forum Network Technology / Network Operations (FNN)"

When using an SMA Flexible Storage System in Germany, the requirements regarding symmetry and monitoring of feed-in power must be implemented in accordance with the Technical Information "Connecting and Operating Storage Units in Low Voltage Networks" published by the FNN. Requirements:

- In these systems, the battery inverter must be connected to the same line conductor supplied by a single-phase PV inverter. If there are only three-phase PV inverters connected, the battery inverter can be connected to any line conductor.
- The requirements of the technical information "Connection and Operation of Storage Units in Low-Voltage Networks" published by the FNN influence the discharge behavior of the battery inverter. When using systems with one battery inverter and single-phase PV inverter, the feed-in power of all inverters (minus the power of the load) must not exceed 4.6 kVA per phase. That is why the SMA Flexible Storage System reduces the maximum discharge power of the battery inverter as required.

Examples for the implementation

In the following illustrations, the Sunny Island is shown as an example for battery inverters. The Sunny Boy Storage must be connected according to the same principles.

Example 1:

All PV inverters are single-phase and are feeding in asymmetrically (Sunny Boy). The PV inverters are connected to one line conductor.

In these systems, the battery inverter must be connected to the same line conductor in which the PV inverters feed into.

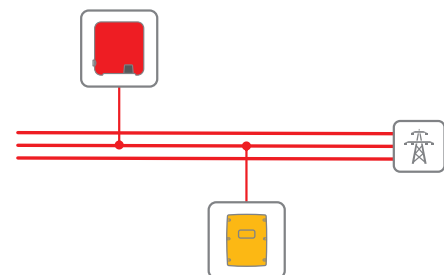

Example 2:

All PV inverters are single-phase and are feeding in asymmetrically (Sunny Boy).

PV inverters are connected to two line conductors.

The battery inverter must be connected to a line conductor via a single-phase PV inverter. TIP: Connect the battery inverter to the line conductor being supplied with the least PV energy. This will increase the control range for increased self-consumption.

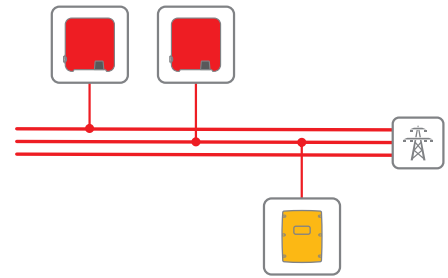
**Example 3:**

All PV inverters are single-phase and are feeding in asymmetrically (Sunny Boy). One PV inverter is connected to each line conductor.

The battery inverter can be connected to any line conductor. TIP: Connect the battery inverter to the line conductor being supplied with the least PV energy. This will increase the control range for increased self-consumption.

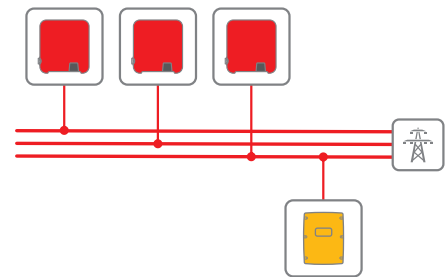
**Example 4:**

All PV inverters are three-phase and are feeding in symmetrically (Sunny Tripower).

The battery inverter can be connected to any line conductor.

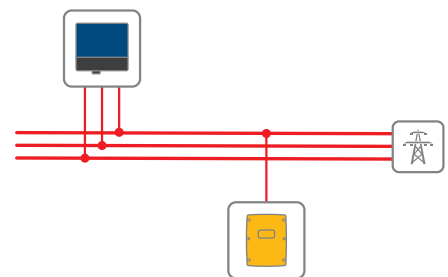
**Example 5:**

The PV system consists of three-phase PV inverters (Sunny Tripower) and single-phase PV inverters (Sunny Boy). The PV system is feeding in asymmetrically.

The battery inverter must be connected to a line conductor via a single-phase PV inverter.

IMPORTANT: The battery inverter can only discharge the battery if less than 4.6 kVA are being fed in on the line conductor of the battery inverter at the point of interconnection.

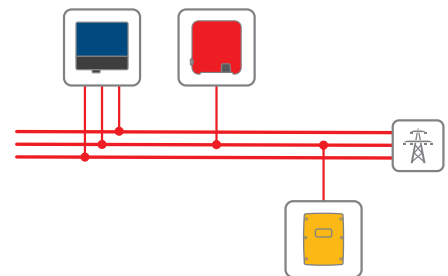
**i Using the Sunny Home Manager 2.0 or SMA Energy Meter**

For the single-phase SMA Flexible Storage System to be able to monitor the limitation of the feed-in power, the Sunny Home Manager 2.0 or the SMA Energy Meter must be used. Only these two devices provide the phase-specific measured values of the feed-in power that are required for the limitation to 4.6 kVA.

The Sunny Home Manager 2.0 or the SMA Energy Meter must also be used for three-phase PV inverters in the single-phase and in the three-phase SMA Flexible Storage System since only these devices supply the measured values at the required level of breakdown.

4.3.4 Power Control in Accordance with the Summation Current Principle

If, with a three-phase grid connection, an SMA Integrated Storage System or a single-phase SMA Flexible Storage System is installed, power control in accordance with the summation current principle also applies.

i Requirement: cumulative meter values

A requirement for power control in accordance with the summation current principle is the output of cumulative meter values in a three-phase system. A cumulative meter value is the total power aggregated over all three phases. A cumulative meter value, however, does not permit any conclusion to be drawn about the state of each individual phase.

The Sunny Home Manager 2.0 and the SMA Energy Meter supply balanced measured values.

In the SMA Integrated Storage System, the Sunny Boy Smart Energy controls the intermediate storage over all three phases of the grid connection. In a single-phase SMA Flexible Storage System, the Sunny Boy Storage or Sunny Island exercises control over the intermediate storage.

For power control in accordance with the summation current principle, the storage system uses the cumulative values of the SMA Energy Meter or of the bidirectional meter for grid feed-in and purchased electricity.

$$P_{\text{total power}} = P_{\text{phase conductor 1}} + P_{\text{phase conductor 2}} + P_{\text{phase conductor 3}}$$

Implementation of the summation current principle is explained below with the example of the SMA Flexible Storage System and three different situations.

Situation 1:

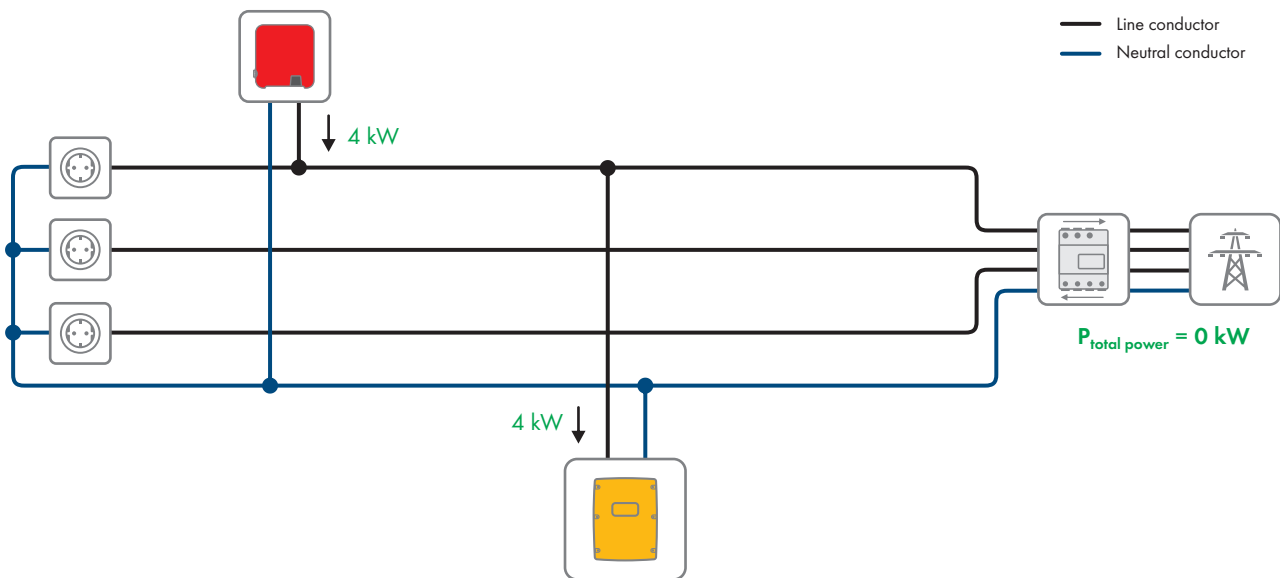

Figure 17: The battery inverter charges the battery.

It is early morning. At sunrise, the PV system begins to feed in and after a while reaches electric power of 4 kW. The loads are still switched off.

$$P_{\text{total power}} = 4 \text{ kW} + 0 \text{ kW} + 0 \text{ kW} = 4 \text{ kW}$$

First, the PV system feeds the total PV power into the utility grid via phase 1. The battery inverter recognizes the grid feed-in and uses the PV power of 4 kW to charge the battery.

$$P_{\text{total power}} = 0 \text{ kW} + 0 \text{ kW} + 0 \text{ kW} = 0 \text{ kW}$$

Energy is no longer fed into the grid.

Situation 2:

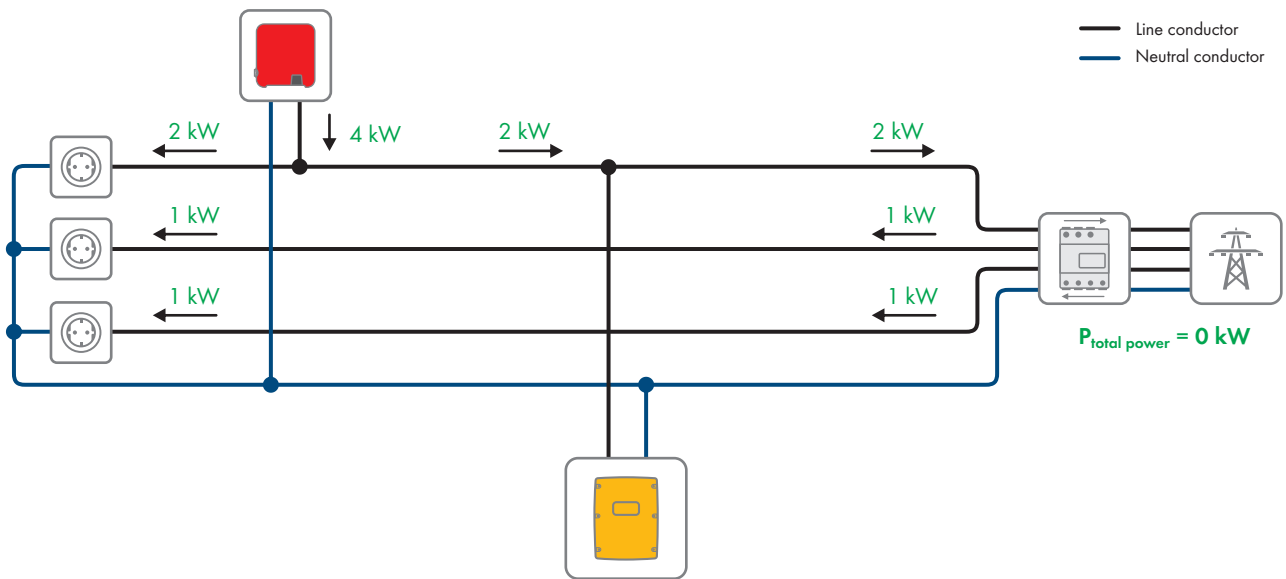

Figure 18: The loads are using the total PV power.

It is around noon. The battery is fully charged. The PV system provides 4 kW. The load on phase 1 uses the power generated by the PV system directly which, therefore, now only feeds 2 kW into the utility grid. The loads on phases 2 and 3 draw their power from the utility grid.

The total power at the bidirectional meter for grid feed-in and purchased electricity is shown as follows:

$$P_{total\ power} = 2\ kW - 1\ kW - 1\ kW = 0\ kW$$

From a cumulative perspective, there is no grid feed-in and no purchase of electricity taking place. The battery inverter does not intervene and leaves the state of charge of the battery unchanged.

Situation 3:

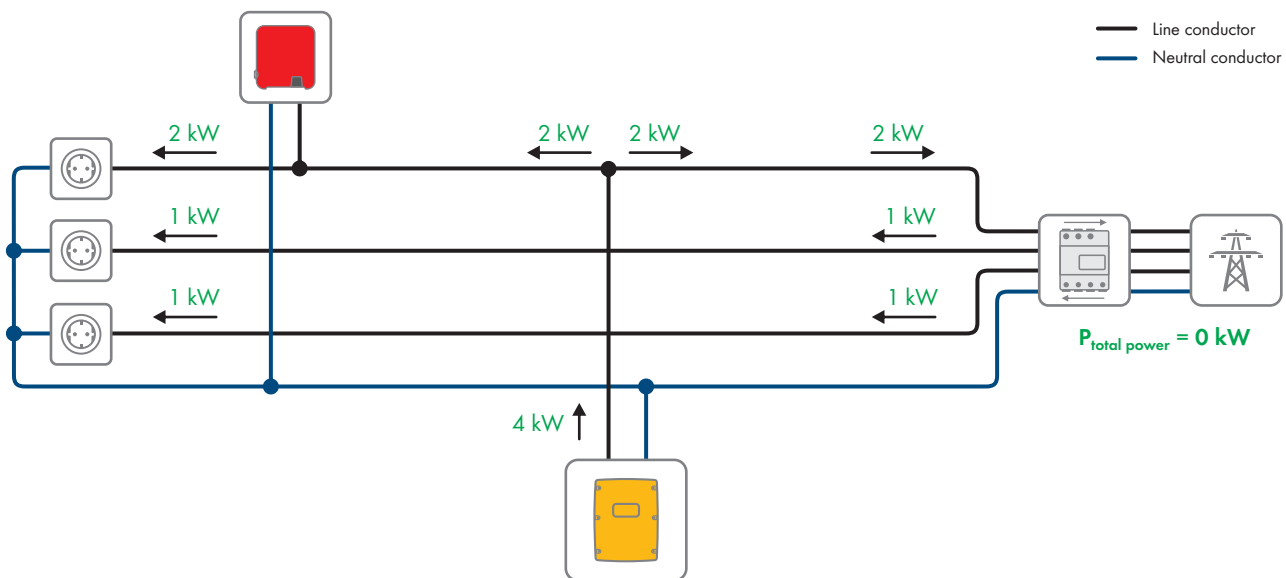

Figure 19: The battery inverter supplies the loads with energy from intermediate storage.

It is now evening. The PV system is not feeding in. The loads are switched on and are drawing 2 kW of electric power on phase 1, 1 kW on phase 2, and 1 kW on phase 3.

The total power at the bidirectional meter for grid feed-in and purchased electricity is shown as follows:

$$P_{\text{total power}} = -2 \text{ kW} - 1 \text{ kW} - 1 \text{ kW} = -4 \text{ kW}$$

The utility grid is now the sole energy source for the loads and supplies them with 4 kW. The battery inverter detects the purchased electricity and consequently uses the energy from intermediate storage to supply the loads.

The total power at the bidirectional meter for grid feed-in and purchased electricity is shown as follows:

$$P_{\text{total power}} = 2 \text{ kW} - 1 \text{ kW} - 1 \text{ kW} = 0 \text{ kW}$$

The energy stored intermediately by the battery inverter in the battery is sufficient to supply the loads. No more electricity is purchased from the grid.

5 Loads in Energy Management Systems

5.1 Suitability of Loads for an Energy Management System

An important form of intelligent energy management is automatic load control. Without any compromises in convenience or supply reliability, the operation of suitable loads is rescheduled to times with high PV generation. To be able to benefit from these advantages, it is important to know which loads are suitable for operation in an energy management system:

- Loads should be capable of consuming a significant portion of the locally generated PV energy. The higher the energy demand of load per day, the more worthwhile is the control of such a load.
- Loads should be in operation either daily or on fixed days during the week.
- Loads should be flexible with regard to time and should not be obliged to produce a specific result immediately after being switched on.

Examples of suitable loads

The following loads are particularly suitable for an energy management system - not least because they are flexible with regard to time:

- A **heat pump** for provision of warm water requires 3 kWh to 5 kWh of energy per day and runs daily.
- A **washing machine** requires 1 kWh to 1.25 kWh of energy depending on the program selected and it runs several times each week.
- A **dryer** requires 1.5 kWh to 2.5 kWh of energy depending on the program selected and it runs several times each week.
- A **dishwasher** requires 1.5 kWh of energy for each wash and typically runs daily.
- A **heating element** for a hot-water tank requires 2 kWh to 3 kWh of energy and is in operation daily.
- A **charging station for electric vehicles** requires 4 kWh to 22 kWh of energy and is in operation daily.

Examples of unsuitable loads

The following loads are unsuitable for an energy management system:

- A **desk lamp** with an energy requirement of e.g. 20 Wh can only consume a very small portion of the PV energy.
- **Toasters** and **kettles** are only switched on when they are required. Toast and hot water are required promptly.
- An **electric cooker** is switched on when the user wishes to cook. The food is to be prepared promptly and not simply whenever sufficient PV energy is available for operation of the electric cooker.

5.2 Options for Load Control

The Sunny Home Manager is offered by many manufacturers of heating systems, charging stations for electric cars and household appliances as an energy manager for use with PV systems. A prerequisite is that there is a compatible controlling interface between the devices and systems in the household via which the Sunny Home Manager can send its control commands.

In principle there are two types of control interfaces for this:

- SMA radio-controlled sockets
- Direct data connection

SMA radio-controlled sockets

i Switching three-phase loads using only one common actuator

Three-phase loads that are dependent on the simultaneous availability of all phases (e.g. three-phase motors), must not be controlled via three separate actuators (e.g. three radio-controlled sockets). In this case, you must use a single actuator with control of a three-phase contactor.

With this type of control, the devices can be started or stopped directly via connecting or interrupting the main power supply (e.g. a pond pump).

Alternatively, a relay or a three-phase contactor, which in turn can start a load, can also be controlled via the radio-controlled socket. This method can be used to switch on large loads (e.g. a large pump or a heater with three-phase power connection).

The so-called SG-Ready switching contacts of heat pumps can also be controlled by radio-controlled sockets or by relay, if necessary. These switching contacts then start the heat pump in a special operating mode in which surplus PV energy can be used to operate the heat pump.

Direct data connection

Some modern home appliances have an Ethernet connection with which the data of the device can be called up via the local network. If there is an Internet connection via the network router, the manufacturers of household devices can use this data for maintenance purposes, for example. Visualization and control of the household devices via mobile devices (e.g. via app in the Smartphone) is also possible with this.

A further application of this direct data connection is the control of the device via the Sunny Home Manager in the energy management system. For this, a compatible data protocol must be implemented in the respective device via which information for energy management can be exchanged. Such data protocols are, for example, the EEBUS/SPINE Standard and the SMA proprietary SEMP protocol (information at www.sma.de/produkte/sma-developer.html).

The smart appliances send information on the load type, the planned energy requirement, and the preferred operating time period to the Sunny Home Manager. The Sunny Home Manager factors this information into its load control, and also taking the configured optimization targets in the context of load control into account, sends appropriate start and stop signals to the loads (see Section 6.2, page 39).

5.3 Control of Heat Pumps

5.3.1 ON/OFF Heat Pumps

An ON/OFF heat pump is a heat pump whose compressor runs with a constant speed during operation and draws a constant level of power. In general, there are three options for controlling ON/OFF heat pumps:

- Control via radio-controlled sockets (230 V on/off)
- Direct control via the SG-Ready input of the heat pump (normal / energy-intensive)
- Direct control via communication using data exchange protocol (SEMP)

Control via radio-controlled sockets (230 V on/off)

ON/OFF heat pumps of the Stiebel WWK electronic and Tecolor TTA series can be controlled by the Sunny Home Manager via radio-controlled sockets. Thereby, the radio-controlled socket must always control the electric circuit that supplies the compressor of the ON/OFF heat pump (for more details on the electrical connection see the manufacturer documentation of the heat pumps).

The following ON/OFF heat pump can be controlled in this way:

Manufacturer	Models
Stiebel Eltron	<ul style="list-style-type: none"> • WWK 220 electronic • WWK 300 electronic / WWK 300 electronic SOL • WWK 221 electronic • WWK 301 electronic / WWK 301 electronic SOL

Manufacturer	Models
Tecalor	<ul style="list-style-type: none"> • TTA 220 electronic • TTA 300 electronic / TTA 300 electronic SOL • TTA 221 electronic • TTA 301 electronic / TTA 301 electronic SOL
AEG Haustechnik	<ul style="list-style-type: none"> • WPT 220 EL / WPT 300 EL / WPT 300 EL plus

Direct control via the SG-Ready input of the heat pump (normal / energy-intensive)

With this type of control, the heat pump is started even if the normal target temperature in the storage tank is reached. A higher target temperature is temporarily activated via the SG-Ready input. This results in the heat pump being forced to run in order to continue heating the water in the tank. The radio-controlled socket must be in "Switch-only mode". In addition, a constant power consumption must be entered in the load profile of the heat pump in Sunny Portal.

Direct control via communication using data exchange protocol (SEMP)

Loads with intelligent communication interface support this type of control (see Section 6.2, page 39).

5.3.2 Inverter Heat Pumps

An inverter heat pump is a heat pump where the rotating speed of the compressor during operation is controlled in such a way that, in accordance with the available temperature profile, an optimum performance level is achieved (CoP). The heat pump control is capable of adjusting the energy consumption according to the situation. If the energy manager specifies a defined, available PV surplus power via the data connection, the heat pump control can refer to this specification and thus actively increase the PV self-consumption.

In general, there are two options for controlling inverter heat pumps:

- Direct control via the SG-Ready input of the heat pump (normal / energy-intensive)
With this type of control, the heat pump selects the power consumption in accordance with its own optimization specifications. Thus, power-based control via the Sunny Home Manager is not possible.
- Direct control via communication using data exchange protocol (SEMP)
With this type of control, the heat pump bases its power consumption on the specifications of the Sunny Home Manager and can therefore be optimally integrated into energy management (see Section 6.2, page 39).

6 Components for Energy Management Systems

6.1 Product Overview

6.1.1 SMA and Radio-Controlled Sockets for Basic Solution

SMA and radio-controlled sockets	Sunny Home Manager
Sunny Home Manager 2.0 incl. integrated measuring device	✓
Compatible WLAN radio-controlled sockets (e.g. Edimax), available via electronics retailers	•
PV inverter*	✓

* To communicate with the Sunny Home Manager, PV inverters need a communication interface via SMA Speedwire fieldbus (see Section 6.3.1, page 40).

✓ Required – Not required • Optional

For the individual products, there are country-specific restrictions on availability (see Section 11.1, page 65).

6.1.2 SMA and Radio-Controlled Sockets for Simple Storage Solution

SMA and radio-controlled sockets	Sunny Boy Smart Energy*	SMA Integrated Storage System
Sunny Home Manager 2.0 incl. integrated measuring device	-	✓
Compatible WLAN radio-controlled sockets (e.g. Edimax), available via electronics retailers	-	•
PV inverter**	Sunny Boy Smart Energy	Sunny Boy Smart Energy

* In order to be able to use the Sunny Boy Smart Energy on its own, an SMA Energy Meter is required additionally.

** In addition to the Sunny Boy Smart Energy, other PV inverters can be used. To communicate with the Sunny Home Manager, PV inverters need a communication interface via SMA Speedwire fieldbus (see Section 6.3.1, page 40). The Sunny Boy Smart Energy already has two integrated Speedwire interfaces for communication, for example, with the Sunny Home Manager.

✓ Required – Not required • Optional

For the individual products, there are country-specific restrictions on availability (see Section 11.1, page 65).

6.1.3 SMA and Radio-Controlled Sockets for Flexible Storage Solution

SMA Flexible Storage System with Sunny Island

SMA and radio-controlled sockets	Sunny Island	Sunny Island with Sunny Home Manager	Sunny Island with Sunny Home Manager and additional energy meter for PV production
Sunny Home Manager 2.0 incl. integrated measuring device	-	✓	✓
Compatible WLAN radio-controlled sockets (e.g. Edimax), available via electronics retailers	-	•	•

SMA and radio-controlled sockets	Sunny Island	Sunny Island with Sunny Home Manager	Sunny Island with Sunny Home Manager and additional energy meter for PV production
PV inverter*	✓	✓	✓**
SMA Energy Meter	✓	-	1 time
Sunny Island 4.4M-12 / 6.0H-12 / 8.0H-12 (with battery fuse)	✓	✓	✓

* To communicate with the Sunny Home Manager, PV inverters need a communication interface via SMA Speedwire fieldbus (see Section 6.3.1, page 40).

** SMA micro inverters or PV inverters from third-party suppliers can be integrated into the SMA Flexible Storage System with Sunny Island, Sunny Home Manager and additional energy meter as PV production meter. In doing so, the additional energy meter must be installed as PV production meter (see Section 6.3.3, page 43). It is recommended to use the SMA Energy Meter as PV production meter.

✓ Required – Not required • Optional

For the individual products, there are country-specific restrictions on availability (see Section 11.1, page 65).

SMA Flexible Storage System with Sunny Boy Storage

SMA and radio-controlled sockets	Sunny Boy Storage	Sunny Boy Storage with Sunny Home Manager	Sunny Boy Storage with Sunny Home Manager and additional energy meter for PV production
Sunny Home Manager 2.0 incl. integrated measuring device	-	✓	✓
Compatible WLAN radio-controlled sockets (e.g. Edimax), available via electronics retailers	-	•	•
PV inverter*	✓	✓	✓**
SMA Energy Meter	✓	-	1 time
Sunny Boy Storage 2.5 / 3.7 / 5.0 / 6.0	✓	✓	✓

* To communicate with the Sunny Home Manager, PV inverters need a communication interface via SMA Speedwire fieldbus (see Section 6.3.1, page 40).

** PV inverters from third-party providers can be integrated into the SMA Flexible Storage System with Sunny Boy Storage, Sunny Home Manager and additional energy meter as PV production meter. In doing so, the additional energy meter must be installed as PV production meter (see Section 6.3.3, page 43). It is recommended to use the SMA Energy Meter as PV production meter.

✓ Required – Not required • Optional

For the individual products, there are country-specific restrictions on availability (see Section 11.1, page 65).

6.2 Home appliances with intelligent communication interface

The following home appliances have been fitted with the energy management data protocol and have been tested with SMA Smart Home:

- Stiebel Eltron heat pumps in conjunction with the Stiebel Eltron ISG web and the EMI software module (as of October 2016)

Integral systems

Air/water heat pumps

Brine-water heat pumps

- LWZ 303/403 (Integral/SOL) from manufacture date 08/2008
- LWZ 304/404 (SOL)
- LWZ 304/404 Trend
- LWZ 504
- WPL 10 I, IK, AC
- WPL 13/20 A basic
- WPL 13-23 E / cool
- WPL 34/47/57
- WPL 15/25 A(C)(S)
- WPF 20-66 / HT
- WPF 04-16 / cool
- WPC 04-13 / cool

- Tecalor heat pumps in conjunction with ISG web and the EMI software module (as of October 2016)

Integral systems

Air/water heat pumps

Brine-water heat pumps

- THZ 303/403 (Integral/SOL) from manufacture date 08/2008
- THZ 304/404 (SOL)
- THZ 304/404 Trend
- THZ 504
- TTL 10 I, IK, AC
- TTL 13/20 A basic
- TTL 13-23 E / cool
- TTL 34/47/57
- TTL 15/25 A(C)(S)
- TTF 10-16 M
- TTF 20-66 / HT
- TTF 04-16 / cool
- TTC 04-13 / cool

- Mennekes AMTRON® wall boxes Xtra and Premium models as charging stations for electric vehicles
- Devices with EEBUS interface (see Technical Information "SMA SMART HOME - Home appliance energy management using EEBus")

6.3 PV Inverters

6.3.1 PV Inverters with Sunny Home Manager

PV inverters can communicate in two different ways in SMA Smart Home with the Sunny Home Manager:

- Wired via Ethernet

The inverter must be connected to the local network via a network cable (e.g. via a router).

- Wireless via WLAN

Depending on the ambient conditions, wireless networks can have a limited range. In free-field conditions without any disruptive objects, a high radio range is possible. Inside buildings, obstacles such as walls, ceilings and doors or other sources of interference can reduce the range to a few meters. Range problems can be eliminated with standard WLAN repeaters.

The Sunny Home Manager supports the following PV inverters from SMA Solar Technology AG. The PV inverters must have the current firmware version in each case (see the inverter product page at www.SMA-Solar.com).

PV Inverters with Integrated Speedwire Interface or Integrated WLAN Interface

Device type	From inverter firmware version
SB1.5-1VL-40 / SB2.5-1VL-40	2.03.01.R
SB 3600SE-10 / SB 5000SE-10	2.3.35.R
SB3.0-1AV-40 / SB3.6-1AV-40 / SB4.0-1AV-40 / SB5.0-1AV-40	1.02.18.R
SB 3000TL-21 / SB 3600TL-21 / SB 4000TL-21 / SB 5000TL-21	2.00.00.R*
SBS2.5-1VL-10	02.02.01.R
SBS3.7-10 / SBS5.0-10 / SBS6.0-10	01.00.63.R
STP3.0-3AV-40 / STP4.0-3AV-40 / STP5.0-3AV-40 / STP6.0-3AV-40	02.11.09.R
STP 50-40	01.01.19.R
STP 5000TL-20/STP 6000TL-20/STP 7000TL-20/STP 8000TL-20/STP 9000TL-20/ STP 10000TL-20/STP 12000TL-20	2.00.15.R
STP 15000TL-30 / STP 20000TL-30 / STP 25000TL-30	02.80.04.R

* This firmware version is the minimum requirement for the function **Limiting of the active power feed-in**.

PV Inverters with Retrofittable Speedwire Interface

Device type
PV inverters which can be retrofitted with Speedwire/Webconnect data module and which support the function "Limitation of active power feed-in"
A list of retrofittable PV inverters can be found in the Speedwire/Webconnect data module installation manual. In the event of an interruption of the communication for system control, the PV inverters must be capable of limiting their active power feed-in to a predefined value (see PV inverter documentation).
PV inverters which can be retrofitted with Speedwire/Webconnect Piggy-Back and which support the function "Limitation of active power feed-in"
A list of retrofittable PV inverters can be found in the Speedwire/Webconnect Piggy-Back installation manual. In the event of an interruption of the communication for system control, the PV inverters must be capable of limiting their active power feed-in to a predefined value (see PV inverter documentation).

Information for All PV Inverters

i Support of the Tigo TS4-R module technology in connection with an SMA string inverter

In Sunny Portal in the system overview, a special tool for the visualization and analysis of the module technology performance is displayed.

i No support for the Sunny Boy 240 and the Sunny Multigate

The Sunny Boy 240 and the Sunny Multigate are not intended for use in Sunny Home Manager systems. Although the Sunny Home Manager can detect the Sunny Multigate, use of the Sunny Home Manager for the configuration of this inverter is not recommended. SMA Solar Technology AG does not accept liability for missing or incorrect data and any yield losses that may result.

i Data on PV generation from the PV inverter

All the SMA PV inverters listed in this section can transmit their PV generation data directly to the Sunny Home Manager. For this reason, a separate PV production meter is not necessary.

If inverters from other manufacturers are to be integrated into the systems, an SMA Energy Meter must be installed centrally as a PV production meter. The PV production meter is then configured appropriately via the Sunny Home Manager settings in Sunny Portal. The generation data from SMA PV inverters is no longer used. For this reason, dynamic active power control in such mixed systems is no longer possible. The inverters must be limited to a fixed active power limit.

i Maximum number of supported PV inverters

The Sunny Home Manager supports a maximum of 24 SMA inverters within one system. This is also the maximum number of devices.

With 24 SMA inverters within one system, radio-controlled sockets or directly controllable loads can no longer be supported.

6.3.2 PV Inverters in the SMA Integrated Storage System

Sunny Boy 3600 / 5000 Smart Energy and other PV inverters	Operating conditions	Permitted
1 Sunny Boy Smart Energy and additional PV inverters	<ul style="list-style-type: none"> The PV inverter must be of the type Sunny Boy or Sunny Tripower. The Sunny Home Manager must be installed. The Sunny Home Manager is part of the SMA Integrated Storage System. If no Sunny Home Manager is installed, the SMA inverters must be equipped with SMA Webconnect. The Sunny Boy 3600 / 5000 Smart Energy should always be connected at the PV array to the string whose PV modules receive the last sunlight of the day. This means that in the evening, full charging of the battery is supported. 	yes
1 Sunny Boy Smart Energy and additional Sunny Boy Smart Energy devices	-	no
1 Sunny Boy Smart Energy and PV inverters from another manufacturer	-	no

The Sunny Boy 3600 / 5000 Smart Energy independently records the PV generation data and sends this data to the Sunny Home Manager. In the SMA Integrated Storage System, therefore, you must not install a PV production meter which sends data for PV generation to the Sunny Home Manager.

If there is a PV production meter in the SMA Integrated Storage System, the Sunny Home Manager can no longer distinguish whether the energy fed into the household grid originates from the PV system or from the battery. If a PV production meter in the SMA Integrated Storage System sends PV generation data to the Sunny Home Manager, PV system monitoring in Sunny Portal is not possible.

6.3.3 PV Inverters in the SMA Flexible Storage System

Sunny Boy Storage or Sunny Island and other PV inverters	Operating conditions	Permitted
Sunny Island with PV inverters	<ul style="list-style-type: none"> The PV inverter must be compatible with the Sunny Home Manager. The PV inverter must not be a Sunny Boy Smart Energy. 	yes
1 Sunny Boy Storage and PV inverter	<ul style="list-style-type: none"> The PV inverter must be of the type Sunny Boy or Sunny Tripower. If the PV inverter is not equipped with SMA Webconnect, the Sunny Home Manager must be installed. 	yes
1 Sunny Boy Storage and additional Sunny Boy Storage devices	–	no
1 Sunny Boy Storage and PV inverters from another manufacturer 1 Sunny Boy Storage and SMA micro inverter	<ul style="list-style-type: none"> An additional energy meter must be installed as a PV production meter. The entire PV generation must be routed via the additional energy meter, otherwise no distinction can be made between PV generation and grid feed-in/purchased electricity. <p>When the additional PV production meter is installed, this value is being taken as PV generation value instead of the values provided by the PV inverter.</p> <ul style="list-style-type: none"> The SMA Energy Meter must be used as a PV production meter. 	yes

6.4 Radio-Controlled Sockets for Load Control

The respective compatible WLAN radio-controlled sockets are listed at www.sma.de on the Sunny Home Manager 2.0 product page in the "Accessories" area. The Edimax SP-2101W WLAN radio-controlled socket is supported from firmware version 2.0.6.R.

Bearing in mind the compatibility of the WLAN Edimax SP-2101W radio-controlled socket with the Sunny Home Manager 2.0, observe the following regarding the firmware version of the devices:

- Sunny Home Manager 2.0 firmware from version 2.0.6.R
- The WLAN Edimax SP-2101W radio-controlled socket up to firmware version 2.08
- The WLAN Edimax SP-2101W V2 radio-controlled socket from firmware version 1.00

Information:

Information: The Sunny Home Manager 2.0 does not support the SMA Bluetooth radio-controlled socket.

The Sunny Home Manager Bluetooth HM-BT-10 does not support any WLAN radio-controlled sockets.

6.5 Energy Measuring Device SMA Energy Meter

The Sunny Home Manager contains an integrated measuring device that corresponds to the measuring function of the SMA Energy Meter. If the Sunny Home Manager 2.0 is installed at the grid-connection point, no further measuring device is necessary for the basic function. Where necessary, an additional SMA Energy Meter can be installed for measuring the PV generation power (see Section 6.3, page 40).

The SMA Energy Meter determines electrical measured values at the connection point and makes them available via Speedwire. The SMA Energy Meter can record energy flows in both directions (counting direction: grid feed-in and purchased electricity or PV generation). It can be connected both three-phase and single-phase.

The SMA Energy Meter is not an energy meter for measuring effective consumption in compliance with the EU directive 2004/22/EC (MID) The SMA Energy Meter must not be used for billing purposes.

The SMA Energy Meter and the Sunny Home Manager 2.0 are licensed for a limiting current of 63 A per line conductor. From firmware version 1.02.04.R of the SMA Energy Meter, installations with more than 63 A per line conductor are possible if one external current transformer is used for each line conductor.

Additional material in the event of more than 63 A per line conductor from firmware version 1.02.04.R:

From firmware version 1.02.04.R of the SMA Energy Meter and for the Sunny Home Manager 2.0, installations with more than 63 A per line conductor are possible. With an SMA Energy Meter installation of more than 63 A per line conductor, one external current transformer is required for each line conductor. SMA Solar Technology AG recommends current transformers designed for a secondary current of 5 A. The current transformers should have at least accuracy class 1.

6.6 Communication

Router

A router/network switch connects the Sunny Home Manager via the Internet to Sunny Portal.

When using the Sunny Home Manager, SMA Solar Technology AG recommends a permanent Internet connection and the use of a router which supports the dynamic assignment of IP addresses (DHCP – Dynamic Host Configuration Protocol).

The values measured by the integrated measuring device is also made available to other devices in the local network via the Ethernet connection of the Sunny Home Manager 2.0 to the router.

SMA Energy Meter

An additional SMA Energy Meter must be located in the same local network as the Sunny Home Manager 2.0. The SMA Energy Meter must also be connected via a network cable either to the network switch or to the router with integrated network switch.

Cable types recommended for the network cable are SF/UTP, S-FTP, S/UTP, SF/FTP, S/FTP and S-STP (for further information on the cable types see Technical Information "SMA SPEEDWIRE FIELDBUS" at www.SMA-Solar.com).

6.7 Maximum Number of Devices in the Energy Management System

The Sunny Home Manager supports a **maximum of 24 devices**.

The term device includes all components that exchange data with the Sunny Home Manager, i.e. SMA inverters, radio-controlled sockets, and smart loads. The SMA Energy Meter is not included in these devices.

Of the 24 devices, a maximum of 12 devices may be actively controlled by the Sunny Home Manager.

Actively controlled means that the Sunny Home Manager not only displays the consumption of the device, but actively switches the device. Even if the limit of a maximum of 12 devices is reached, further devices can be monitored via radio-controlled sockets and visualized, so long as the maximum number of devices of 24 is not exceeded.

**Fully equipped energy management system**

A fully equipped energy management system (with a maximum of 24 devices) can consist of the following components:

- 3 x SMA Inverters
- 1 x heat pump that is controlled by the Sunny Home Manager via a direct data connection.
- 20 x radio-controlled sockets

Due to the actively controlled heat pump, only eleven radio-controlled sockets can be actively controlled by the Sunny Home Manager.

7.2 Material for Circuitry of the System with One Sunny Island

Material	Number of units	Description
Circuit breaker for protection of the Sunny Island	1	32 A, C rating, 1-pole
Residual-current device	1	40 A/0.03 A, 1-pole + N, type A

Wiring diagram will be supplied whenever a Sunny Island 4.4M / 6.0H / 8.0H is ordered.

7.3 Circuitry Overview for a System with One Sunny Boy Storage

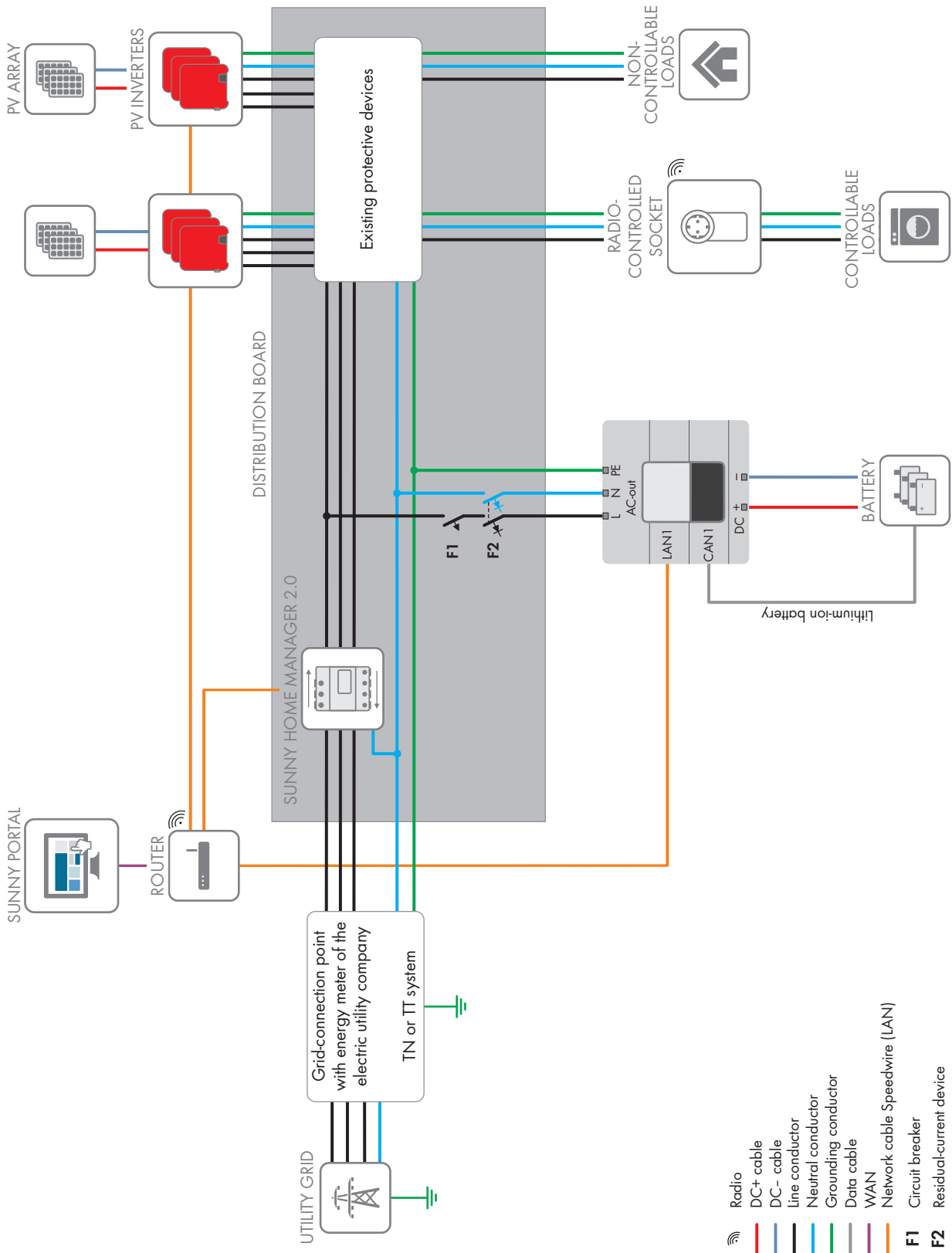

Figure 21: Circuitry of the SMA Flexible Storage System

7.4 Material for Circuitry of the System with One Sunny Boy Storage

Material	Number of units	Description
Circuit breaker for protection of the Sunny Boy Storage	1	For information and design examples, see the Technical Information "Circuit Breaker" at www.SMA-Solar.com
Residual-current device	1	If an external residual-current device is required, install a residual-current device which trips at a residual current of 100 mA or higher (for details on selecting a residual-current device, see the Technical Information "Criteria for Selecting a Residual-Current Device" at www.SMA-Solar.com).

7.5 Circuitry Overview for a System with Three Sunny Island Inverters

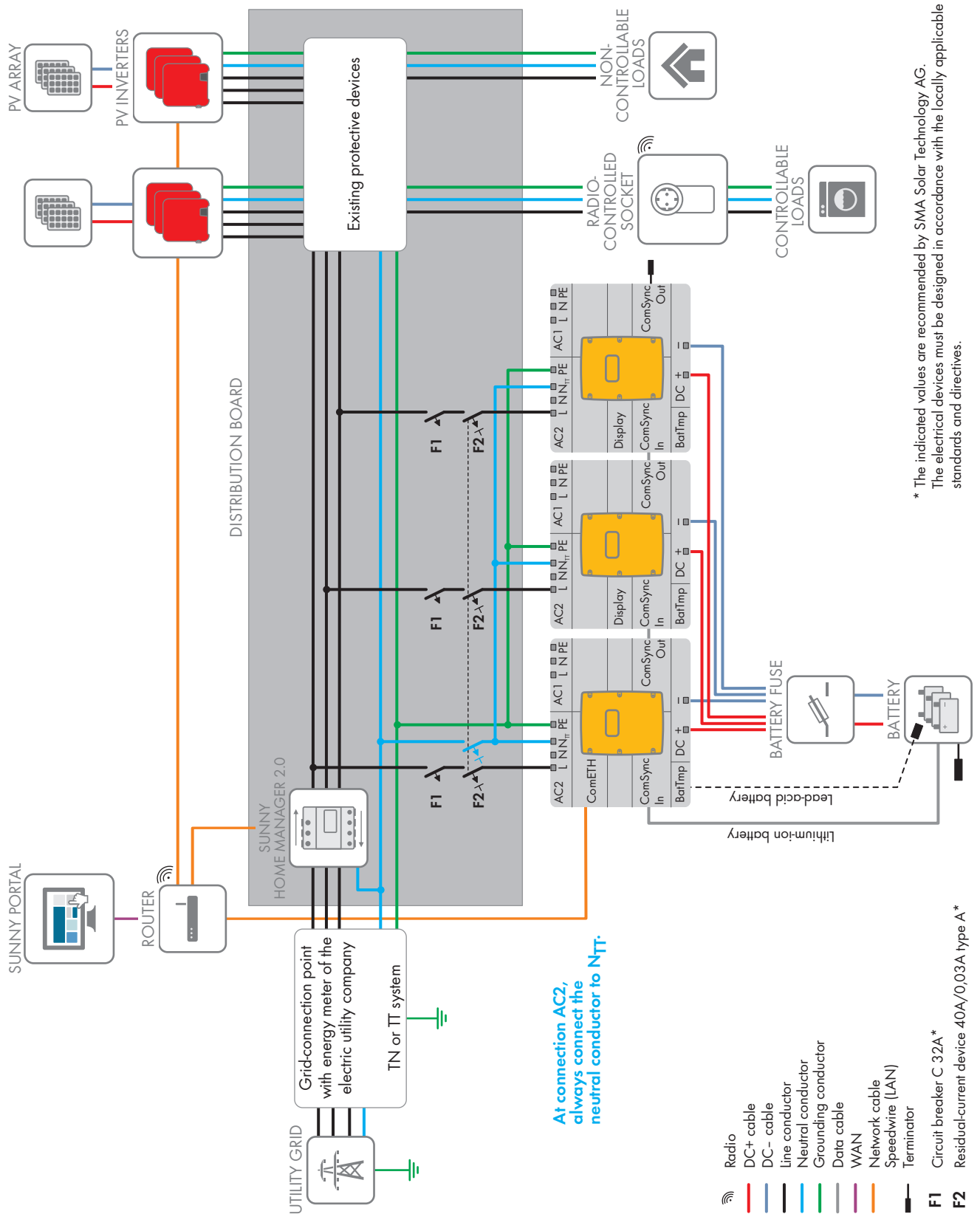

Figure 22: SMA Flexible Storage System for TN and TT systems

7.6 Material for Circuitry of the System with Three Sunny Island Inverters

Material	Number of units	Description
Circuit breaker for protection of the Sunny Island	3	32 A, C rating, 1-pole
Residual-current device	1	40 A/0.03 A, 1-pole + N, type A

Wiring diagram will be supplied whenever a Sunny Island 4.4M / 6.0H / 8.0H is ordered.

7.7 Supported Batteries

Sunny Island

The Sunny Island supports lead-acid batteries of types FLA and VRLA as well as various lithium-ion batteries. It is important to observe the capacity:

- Lead-acid batteries with a capacity of 100 Ah to 10000 Ah can be connected.
- Lithium-ion batteries with a capacity of 50 Ah to 10000 Ah can be connected.

This corresponds to a maximum storage capacity of 480 kWh for a battery with 48 V and 10000 Ah.

A lithium-ion battery is especially suited for intermediate storage of PV energy due to its high cycle stability. The lithium-ion batteries must be compatible with the Sunny Island:

- The battery must comply with the locally applicable standards and directives and must be intrinsically safe.
- The lithium-ion battery must be approved for use with the Sunny Island.

The list of lithium-ion batteries approved for the Sunny Island is updated regularly (see the technical information "List of Approved Batteries" at www.SMA-Solar.com).

- If no lithium-ion battery approved for the Sunny Island can be used, use a lead-acid battery.

Sunny Boy Storage

The Sunny Boy Storage must only be operated in connection with an intrinsically safe lithium-ion battery approved by SMA Solar Technology AG (see Technical Information "Approved batteries and battery communication connection" at www.SMA-Solar.com).

Lithium-ion battery for Sunny Island and Sunny Boy Storage

The battery management of lithium-ion batteries controls the operation of the battery. To enable battery management, the lithium-ion battery must be connected to the battery inverter via a data cable.

In the case of compatible lithium-ion batteries, SMA Solar Technology AG has only tested the interaction between the battery inverter and the battery management of the lithium-ion battery. For information on other technical properties of the batteries, please contact the respective manufacturer of the lithium-ion battery.

7.8 System Design of an SMA Flexible Storage System with Diagrams

The design serves as an orientation and a starting point for in-depth system planning. The considerations on system planning put forward in this section refer exclusively to intermediate storage of PV energy in the SMA Flexible Storage System.

In order to design the system using these diagrams, the following starting parameters must be known:

- Peak power of the PV system
- Usable battery capacity
- Annual energy demand of the loads

Diagrams for System Design

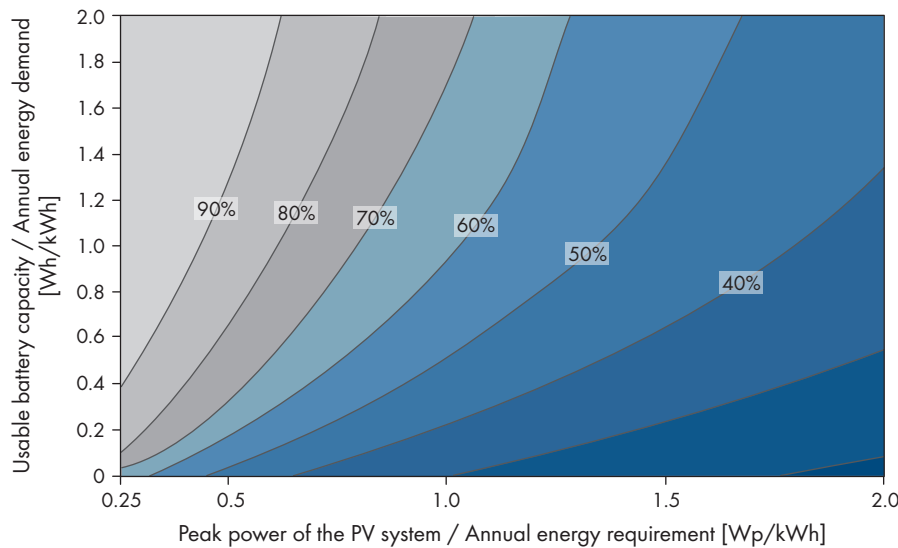

Figure 23: Estimation of the self-consumption quota

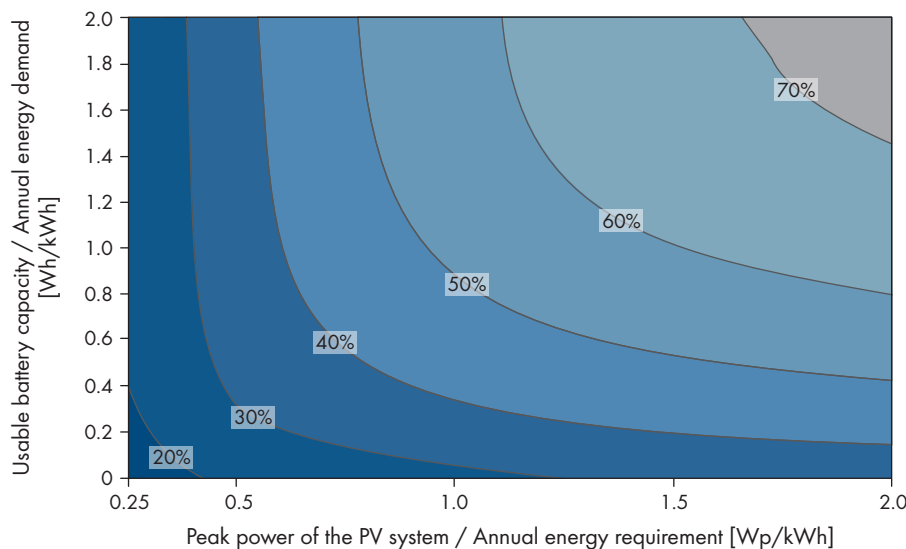

Figure 24: Estimation of the self-sufficiency quota

Step 1: Estimating the Self-Consumption Quota for Energy Management without Intermediate Storage

To design an SMA Flexible Storage System, you estimate in the first step the possible self-consumption quota for energy management without intermediate storage. The self-consumption quota for energy management without intermediate storage always takes into account the natural self-consumption attainable in one year which is dependent on the annual energy demand and on the peak power of the PV system. Increased self-consumption through automatic load control also influences the self-consumption quota for energy management without intermediate storage.

Input data (example):

- Peak power of the PV system: 5000 Wp
- Annual energy demand: 5000 kWh
- Usable battery capacity: 0 Wh, as in step 1 the self-consumption quota is estimated without intermediate storage.

$$\frac{\text{Peak power}}{\text{Annual energy requirement}} = \frac{5,000 \text{ Wp}}{5,000 \text{ kWh}} = 1 \text{ Wp/kWh}$$

$$\frac{\text{Usable battery capacity}}{\text{Annual energy demand}} = \frac{0 \text{ Wh}}{5000 \text{ kWh}} = 0 \text{ Wh/kWh}$$

Transfer the calculated values to the diagram to estimate the self-consumption quota.

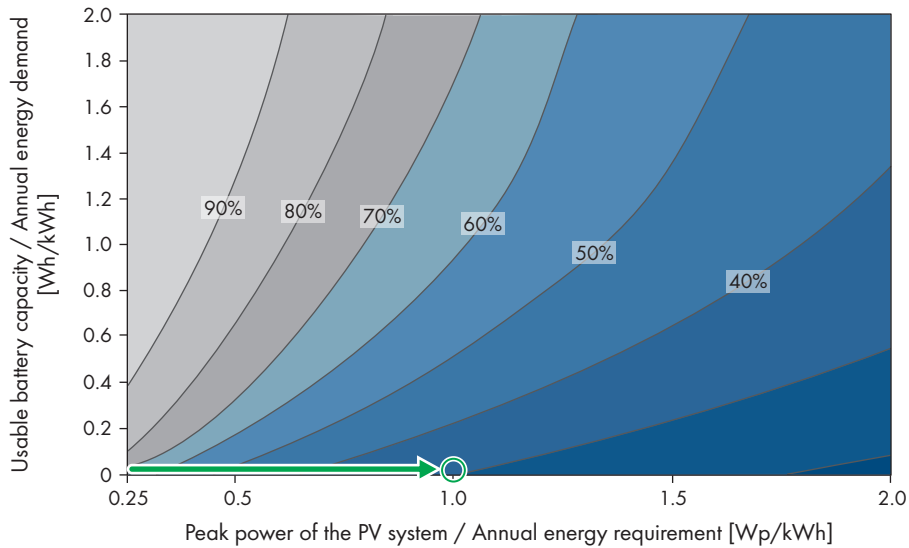

Figure 25: Estimation of the self-consumption quota without intermediate storage

The estimate reveals that, with energy management without intermediate storage, the on-site loads use 30% of the generated PV energy.

Step 2: Estimating the Self-Consumption Quota for Energy Management with Intermediate Storage

With the SMA Flexible Storage System, you can influence the self-consumption quota by changing the battery capacity. You must bear in mind that intermediate storage of the PV energy requires frequent charging and discharging of the battery. This frequent charging and discharging quickly raises the number of battery charging cycles. The maximum number of charging cycles of a battery is limited and depends on the used battery capacity. The number of possible charging cycles does, however, influence the service life of a battery.

To extend the service life of the battery, the Sunny Island uses only a portion of the total battery capacity for intermediate storage. This portion depends on the battery technology used and is referred to as usable battery capacity in the following. The usable battery capacity can be configured on the Sunny Island.

With lead-acid batteries, the usable battery capacity is approximately 50% of the total battery capacity, and for lithium-ion batteries it is approximately 80%. For detailed information on the usable battery capacity and the possible charging cycles, contact the battery manufacturer.

i Usable battery capacity when the Sunny Island battery is operated seasonally

Due to the seasonal battery operation of the Sunny Island, the use of the battery for intermediate storage is limited in winter and extended in summer. Therefore, a usable range of 50% for intermediate storage can serve as the basis for the estimate.

Input data (example):

- Peak power of the PV system: 5000 Wp
- Annual energy demand: 5000 kWh
- Total battery capacity: 10000 Wh, of which the Sunny Island uses 50% for intermediate storage of PV energy.

The usable battery capacity therefore amounts to 5000 Wh.

$$\frac{\text{Peak power}}{\text{Annual energy requirement}} = \frac{5,000 \text{ Wp}}{5,000 \text{ kWh}} = 1 \text{ Wp/kWh}$$

$$\frac{\text{Usable battery capacity}}{\text{Annual energy demand}} = \frac{5000 \text{ Wh}}{5000 \text{ kWh}} = 1 \text{ Wh/kWh}$$

Transfer the calculated values to the diagram to estimate the self-consumption quota.

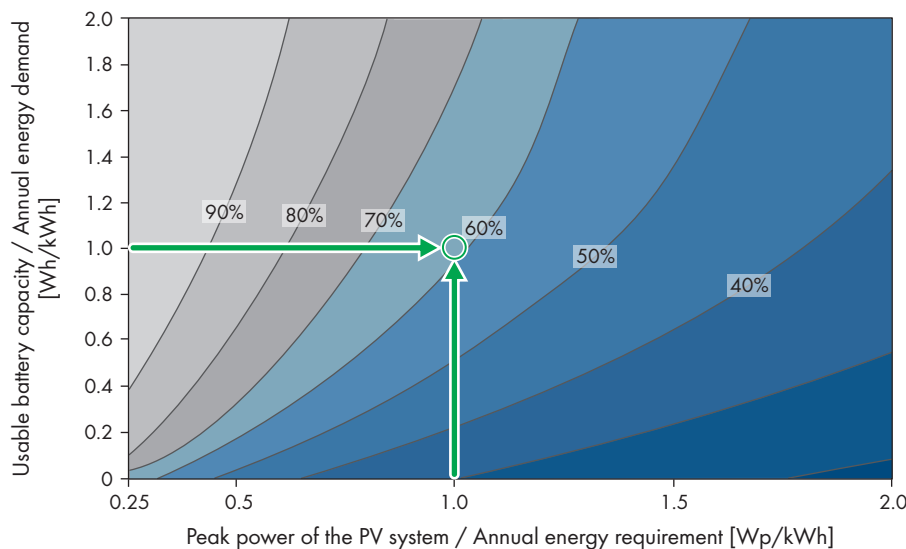

Figure 26: Estimation of the self-consumption quota with intermediate storage

The estimate reveals that the self-consumption quota, with energy management with intermediate storage, is approximately 60%.

Step 3: Calculating Increased Self-Consumption through Intermediate Storage of the PV Energy

Input data (example):

- Self-consumption quota with energy management without intermediate storage: 30%
- Self-consumption quota with energy management with intermediate storage: 60%

$$\begin{array}{l} \text{Self-consumption rate} \\ \text{with buffering} \end{array} - \begin{array}{l} \text{Self-consumption rate} \\ \text{without buffering} \end{array} = 60\% - 30\% = 30 \text{ percentage points}$$

In this example, the self-consumption quota increased by 30 percentage points due to intermediate storage of energy.

Step 4: Estimating the Battery Service Life

Taking the guaranteed PV feed-in tariff for a 20-year period as a basis, the battery will need to be replaced at least once due to its calendar life expectancy. Therefore, for optimal efficient use of the battery, we recommend that you replace it after approximately ten years.

The first step in sizing the battery consists of establishing the number of annual nominal energy throughputs. In one nominal energy throughput, the battery is fully discharged once and then charged again to 100%. The number of nominal energy throughputs per year can be calculated as follows:

$$\text{Annual nominal energy throughput} = \frac{\text{Generated PV energy} \cdot \text{increased self-consumption}}{\text{Total battery capacity}}$$

You can calculate the battery life using the total number of nominal energy throughputs for 100% cycles specified by the battery manufacturer:

$$\text{Battery life} = \frac{\text{Total number of nominal energy throughputs}}{\text{Annual nominal energy throughput}}$$

Input data (example):

- Generated PV energy: 4500 kWh (assumed value for a PV system in central Germany with a peak power of 5000 W_p of the PV system)
- Increased self-consumption (step 3): 30 percentage points
- Total battery capacity: 10 kWh
- Total number of nominal energy throughputs for 100% cycles: 1200 (lead-acid battery, OPzV, from the datasheet of a battery manufacturer)

$$\text{Annual nominal energy throughput} = \frac{4500 \text{ kWh} \cdot 0.30}{10 \text{ kWh}} = 135$$

$$\text{Battery life} = \frac{1200}{135/\text{a}} = 8.89 \text{ years} \sim 9 \text{ years}$$

i Influence of battery capacity on battery life

To increase a battery life that is too short, you can select a larger battery capacity. Changing the battery capacity also results in a change in increased self-consumption.

- Repeat current system design from step 2.

Step 5: Estimating the Self-Sufficiency Quota for Energy Management without Intermediate Storage

Input data (example):

- Peak power of the PV system: 5000 W_p
- Annual energy demand: 5000 kWh
- Usable battery capacity: 0 Wh, as in step 5, the self-sufficiency quota for energy management without intermediate storage is estimated.

$$\frac{\text{Peak power}}{\text{Annual energy requirement}} = \frac{5,000 \text{ Wp}}{5,000 \text{ kWh}} = 1 \text{ Wp/kWh}$$

$$\frac{\text{Usable battery capacity}}{\text{Annual energy demand}} = \frac{0 \text{ Wh}}{5000 \text{ kWh}} = 0 \text{ Wh/kWh}$$

Transfer the calculated values to the diagram to estimate the self-sufficiency quota.

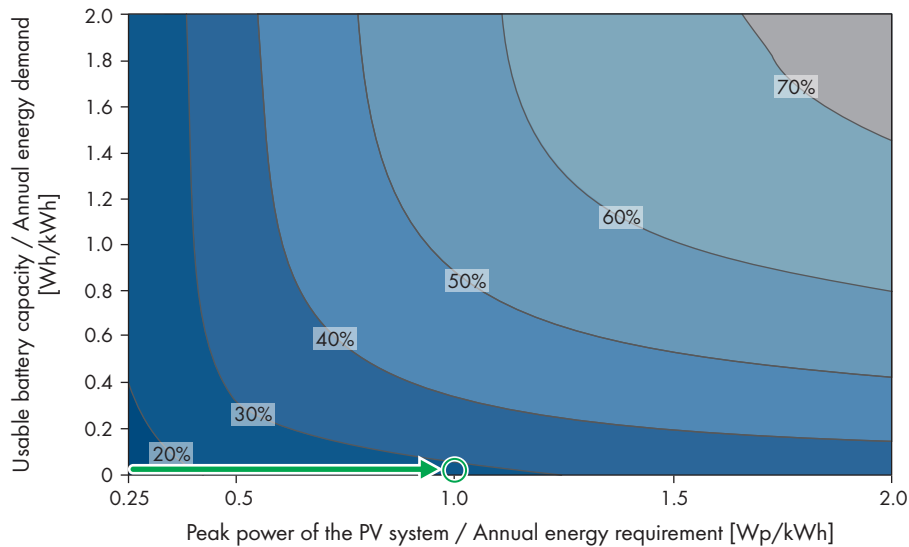

Figure 27: Estimation of the self-sufficiency quota without intermediate storage

The estimate reveals that with energy management without intermediate storage, a self-sufficiency quota of approximately 28% is achieved.

Step 6: Estimating the Self-Sufficiency Quota for Energy Management with Intermediate Storage

Input data:

- Peak power of the PV system: 5000 W_p
- Annual energy demand: 5000 kWh
- Total battery capacity: 10000 Wh, of which the Sunny Island uses 50% for intermediate storage of the PV energy.

The usable battery capacity therefore amounts to 5000 Wh.

$$\frac{\text{Peak power}}{\text{Annual energy requirement}} = \frac{5,000 \text{ W}_p}{5,000 \text{ kWh}} = 1 \text{ W}_p/\text{kWh}$$

$$\frac{\text{Usable battery capacity}}{\text{Annual energy demand}} = \frac{5000 \text{ Wh}}{5000 \text{ kWh}} = 1 \text{ Wh}/\text{kWh}$$

Transfer the calculated values to the diagram to estimate the self-sufficiency quota.

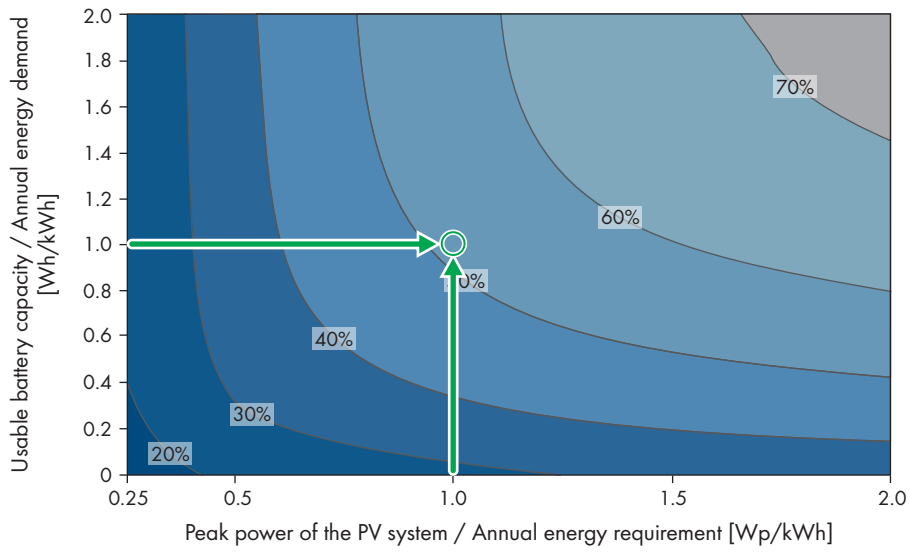

Figure 28: Estimation of the self-sufficiency quota with intermediate storage

The estimate reveals that the self-sufficiency quota, with energy management with intermediate storage, is approximately 52%.

8 PV System Design with Sunny Design

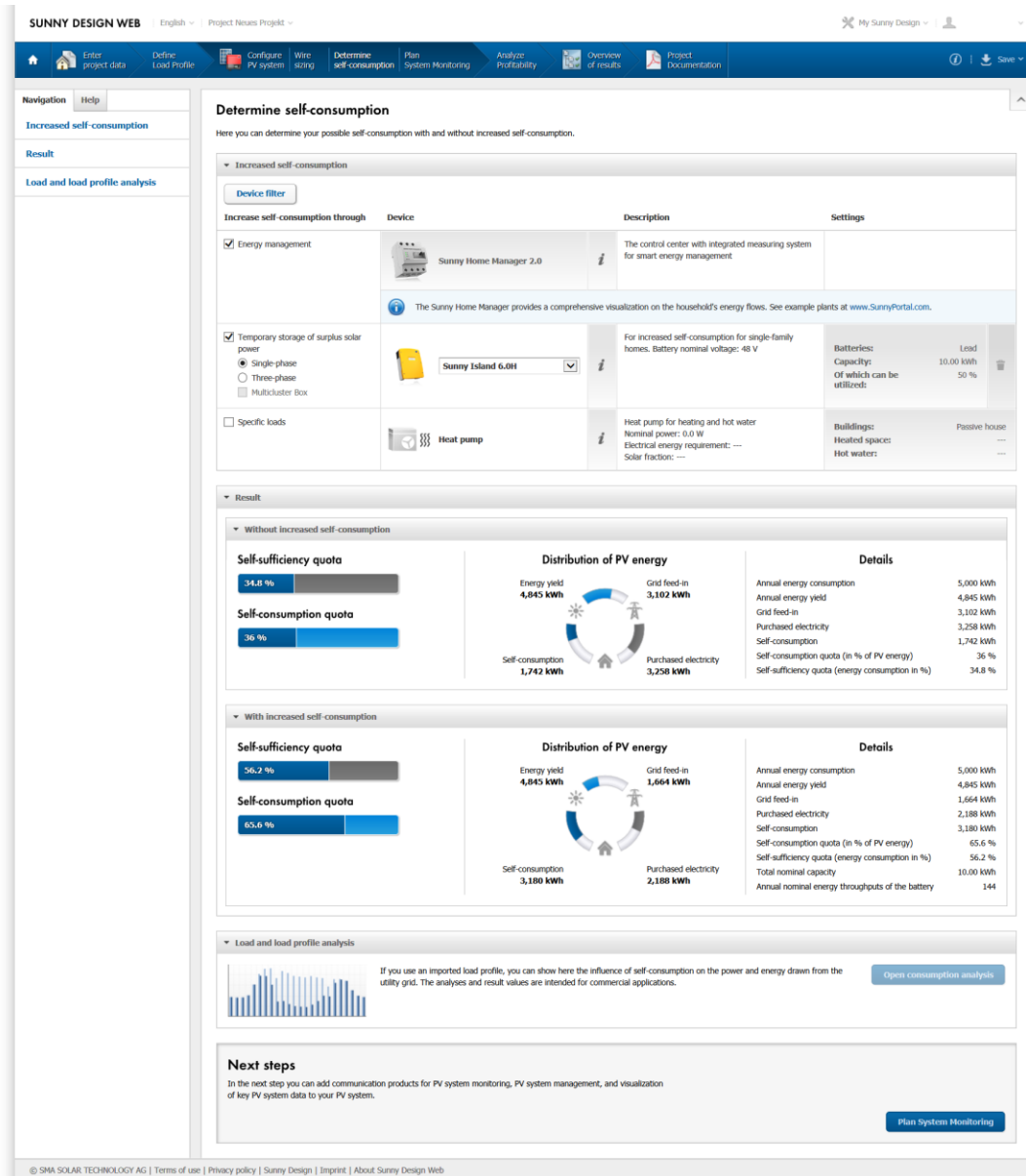

Figure 29: Example for designing a system with Sunny Design Web

Sunny Design is a software package for planning and designing PV systems and PV hybrid systems. Sunny Design provides you with recommendations on possible designs for your PV system or your off-grid system.

Sunny Design is available as an online version - Sunny Design Web - and as a desktop version - Sunny Design 3. You can only use the Sunny Design Web online version via the Internet (www.SunnyDesignWeb.com). You must install the desktop version of Sunny Design 3 on your computer, but once registered, you do not need an Internet connection (for documentation and download, see www.SMA-Solar.com).

9 Frequently Asked Questions

Is it possible to measure currents of more than 63 A per line conductor with the SMA Energy Meter and/or Sunny Home Manager 2.0?

From firmware version 1.02.04.R of the SMA Energy Meter, installations with more than 63 A per line conductor are possible if one external current transformer is used for each line conductor. SMA Solar Technology AG recommends current transformers designed for a secondary current of 5 A. The current transformers should have at least accuracy class 1.

Can I only use the Sunny Boy Smart Energy within the SMA Integrated Storage System?

If no automatic load control is required, you can also equip a PV system solely with the Sunny Boy Smart Energy. With this option however, you implement only the intermediate storage of PV energy. To use the Sunny Boy Smart Energy without the Sunny Home Manager, you require an SMA Energy Meter and a router/network switch for the Internet connection to Sunny Portal.

Can I also use the Sunny Boy Smart Energy as an off-grid system or as a battery-backup system?

The Sunny Boy Smart Energy must not be used in off-grid systems or in battery-backup systems since it cannot provide its own utility grid. To set up an off-grid system or a battery-backup system, SMA Solar Technology AG offers the Sunny Island (for information on the Sunny Island in an off-grid system and in the SMA Flexible Storage System with a battery-backup function, see www.SMA-Solar.com).

Is the Sunny Boy Smart Energy compatible with other battery types?

No: The Sunny Boy Smart Energy must only be operated with the Battery Pack Smart Energy of type "BAT-2.0-A-SE-10".

Is the SMA Integrated Storage System also available with a larger battery capacity?

No: The Sunny Boy Smart Energy is fitted with one Battery Pack Smart Energy with a battery capacity of 2 kWh. The usable battery capacity of the SMA Integrated Storage System therefore amounts to 2 kWh. Increasing the battery capacity through an additional Battery Pack Smart Energy is not possible.

Is a three-phase implementation of the SMA Integrated Storage System also possible?

No: Parallel operation of multiple Sunny Boy Smart Energy devices is not possible.

Can devices with BLUETOOTH interface also communicate with the Sunny Boy Smart Energy?

No: The Sunny Boy Smart Energy has only two Speedwire interfaces. These enable fast and secure communication but require a connection with network cables.

Can devices with BLUETOOTH interface also communicate with the Sunny Boy Storage?

No: The Sunny Boy Storage, however, is equipped with a Speedwire and WLAN interface.

Can existing PV systems be retrofitted with the Sunny Home Manager or the SMA Flexible Storage System?

Yes: New and existing PV systems can be retrofitted with the Sunny Home Manager or the SMA Flexible Storage System.

Do any limitations apply to the PV System when using the SMA Flexible Storage System?

No: The SMA Flexible Storage System is technically independent of the peak power of the PV system. Whether the intermediate storage of PV energy on site makes economic sense will need to be evaluated in each individual case:

- Use Sunny Design Web to design and evaluate an SMA Flexible Storage System (for Sunny Design, see www.SMA-Solar.com).
- Use the method described in this document to design and evaluate an SMA Flexible Storage System (see Section 7.8, page 51).

Can PV inverters from other manufacturers be installed together with a Sunny Island or a Sunny Boy Storage?

If you want to retrofit an existing PV system with the Sunny Island or a Sunny Boy Storage for intermediate storage of PV energy, but do not require active power limitation, you can use PV inverters from any manufacturer. Active power limitation may be stipulated by the grid operator or may bring financial rewards due to local legislation (e.g. the PV storage incentive program in Germany). If the active power limitation is required, the selected inverters must ensure the limitation.

Which batteries can be used with the SMA Flexible Storage System?

The Sunny Island supports all lead-acid batteries of types FLA and VRLA as well as various lithium-ion batteries (see Section 7.7, page 51). The Sunny Boy Storage supports selected lithium-ion batteries (see Technical Information "Approved batteries and battery communication connection" at www.SMA-Solar.com).

Which battery capacities can be implemented with the SMA Flexible Storage System?

The battery capacity for an SMA Flexible Storage System with Sunny Island can be freely selected within a wide range.

The Sunny Island supports lead-acid batteries of types FLA and VRLA as well as various lithium-ion batteries. It is important to observe the capacity:

- Lead-acid batteries with a capacity of 100 Ah to 10000 Ah can be connected.
- Lithium-ion batteries with a capacity of 50 Ah to 10000 Ah can be connected.

This corresponds to a maximum storage capacity of 480 kWh for a battery with 48 V and 10000 Ah.

The battery capacity for an SMA Flexible Storage System with Sunny Boy Storage is prescribed by the lithium-ion battery used.

Is it possible, in addition to the PV system, to connect other AC sources to the SMA Flexible Storage System?

You can also connect other AC sources to a Sunny Island or Sunny Boy Storage, for example, a combined heat and power plant (CHP plant). Keep in mind that within the SMA Flexible Storage System, the Sunny Home Manager does not support wind power inverters or CHP plants.

If your system combines various AC power sources (e.g. PV system and wind energy inverters or CHP plants), then the Sunny Island can only detect the PV inverters and limit their power. No wind power inverters or CHP plants are displayed in Sunny Portal for the SMA Flexible Storage System.

Since the data from wind power inverters or CHP plants is not taken into account by the Sunny Island, the data calculated in Sunny Portal and the displayed diagrams may be inaccurate.

Can I connect a single-phase system for intermediate storage of energy to a three-phase PV inverter?

Yes: Single-phase battery-backup grids can be connected to three-phase utility grids.

Note: With single-phase Sunny Island systems for intermediate storage with three-phase inverters, the optional battery-backup function only works to a limited extent since, in the event of a grid failure, the three-phase PV inverter can not be used for battery recharge (see Planning Guidelines "SMA FLEXIBLE STORAGE SYSTEM with Battery-Backup Function" at www.SMA-Solar.com).

How much maintenance work does the SMA Flexible Storage System involve?

The Sunny Island and the Sunny Boy Storage are largely maintenance-free (see operating manual of the inverter). Information on battery maintenance can be obtained from the battery manufacturer.

Will I receive information on the Sunny Boy Storage in Sunny Portal?

Yes: The Sunny Boy Storage is equipped with a Webconnect function as standard. The Webconnect function enables direct data transmission between the inverters of a small-scale system and the Internet portal Sunny Portal without any additional communication device and for a maximum of four inverters per Sunny Portal system. It is also possible to integrate the Sunny Boy Storage into Sunny Portal via Sunny Home Manager.

What rated power does the Sunny Island have?

For intermediate storage of PV energy in Germany, the output power of the Sunny Island is limited to 4.6 kW per phase due to the standard requirements.

Product	Sunny Island rated output power
Sunny Island 4.4M	3300 W
Sunny Island 6.0H	4600 W
Sunny Island 8.0H	6000 W

What rated power does the Sunny Boy Storage have?

For intermediate storage of PV energy in Germany, the output power of the Sunny Island is limited to 4.6 kW per phase due to the standard requirements.

Product	Sunny Boy Storage rated output power
Sunny Boy Storage 2.5	2500 W
Sunny Boy Storage 3.7	3680 W
Sunny Boy Storage 5.0	5000 W
Sunny Boy Storage 6.0	6000 W

Is it possible for two Sunny Island or Sunny Boy Storage devices to feed in via a single phase?

No: Only one Sunny Island or Sunny Boy Storage per phase is allowed to feed in.

Can I use a Sunny Island or Sunny Boy Storage only within the SMA Flexible Storage System?

If no automatic load control and no limitation of the active power feed-in are required, you can equip a PV system solely with a Sunny Island or Sunny Boy Storage and do without the complete SMA Flexible Storage System installation. With this option however, you implement only the intermediate storage of PV energy.

For a purely Sunny Island storage system, the following SMA products are required:

- Sunny Island 4.4M / 6.0H / 8.0H (SI4.4M-12 / SI6.0H-12 / SI8.0H-12)
- SMA Energy Meter

In a Sunny Island storage system, the SMA Energy Meter must be connected directly to the Sunny Island via a network cable. The Sunny Island receives no data regarding PV generation. This means that the Sunny Island cannot display some of its parameters, e.g. the increased self-consumption values.

For a purely Sunny Boy Storage system, the following SMA products are required:

- Sunny Boy Storage
- SMA Energy Meter

Can the Sunny Boy Storage be operated with three phases?

No: The Sunny Boy Storage can only be operated with one phase.

Can the Sunny Island or the Sunny Boy Storage without a Sunny Home Manager limit active power feed-in of a PV system ?

Yes: The Sunny Island or the Sunny Boy Storage without a Sunny Home Manager is able to limit active power feed-in of a PV system under the following conditions:

- Only the following device types may be used with the Sunny Island for the active power limitation: SI4.4M-12 / SI6.0H-12 / SI8.0H-12.
- A maximum of three PV inverters can be installed in the PV system.
- All PV inverters in the PV system must be equipped with Webconnect function.
- An SMA Energy Meter must be installed.

Can the Sunny Boy Storage be used as WLAN access for PV inverters?

No: As all network participants, PV inverters also need a direct WLAN access.

10 Explanation of Used Terms

Term	Explanation
Self-sufficiency quota	Current ratio of internal power supply to total consumption The loads can cover their energy demand from the PV system, from the utility grid, and from any available batteries.
Battery discharging	Power that is currently being drawn from the battery. Battery discharging takes place when the energy demand of the loads exceeds the current power of the PV system.
Battery charging	Power that is being currently charged from your system into the battery
Battery cycle	In a battery cycle, the battery is discharged once from 100% of the nominal capacity to a depth of discharge specified by the manufacturer and then recharged up to 100% of the nominal capacity.
Direct consumption	Power that the loads draw directly from the PV system Flexible loads are switched on at the time when their energy demand is completely covered by the PV system.
Self-consumption	Generated PV power is consumed at the site where it is generated. Self-consumption is made up of direct consumption and battery charging.
Self-consumption quota	Current ratio of self-consumption to PV power
Internal power supply	Supply of loads with PV energy generated on site Internal power supply is made up of direct consumption and battery discharging.
Intermediate storage	Battery charging and discharging as a measure of energy management The intermediate storage enables the consumption of PV energy independent of the time of generation, e.g. in the evening or during bad weather. This means that time-controlled electrical appliances can also be operated with PV energy.
Energy management	The total of all measures to optimize the consumption of the energy made available by a PV system. The objective of energy management is either the highest possible self-sufficiency quota or the highest possible self-consumption quota.
Energy management system	System for optimizing energy flows automatically and intelligently, for increasing self-consumption or improving internal power supply
Battery-backup function	Capacity of an energy management system to also function as a battery-backup system (in the context of these planning guidelines)
Battery-backup system	In the event of grid failure, a battery-backup system supplies loads with energy and a PV system disconnected from the utility grid with voltage. In this case, in the event of grid failure, the battery-backup system automatically switches from the utility grid to the alternative energy source, e.g. PV system and battery.
FNN	Forum network technology / network operation in the VDE

Term	Explanation
Natural self-consumption	A typical four-person household in Germany, with a 5 kWp PV system, achieves a self-consumption quota of approximately 30% through natural self-consumption. However, this is only a rough approximate value due to the dependence of the self-consumption quota on the individual generation profile and the load profile. The orientation of the PV array, the weather, and temporary shading are decisive factors determining the individual generation profile, while individual consumption habits are decisive for the load profile.
Grid failure	Failure of the utility grid If the utility grid deviates from the country-specific thresholds for voltage and frequency, the Sunny Island will react in the same way as if a utility grid failure has occurred.
Purchased electricity	Electric power that is currently being drawn from the utility grid
Purchased electricity meter	Energy meter for recording purchased electricity
Grid feed-in	Electric power that is currently being fed into the utility grid
Feed-in meter	Energy meter for recording the grid feed-in
PV generation	Electric power that is currently being provided by the PV system
PV production meter	Energy meter for recording the PV generation
VDE	Association for Electrical, Electronic and Information Technologies, its sciences and the technologies and procedures based on them
Cycle stability	Characteristic for the service life of a battery The cycle stability indicates how many times a battery can be discharged and charged before the available battery capacity falls below a specific value (see the battery manufacturer's specifications).

11 Appendix

11.1 Country-Dependent Availability of the SMA Products

Sunny Home Manager 2.0 and SMA Energy Meter

Country	Sunny Home Manager 2.0	SMA Energy Meter
Australia	✓	✓
Belgium	✓	✓
Denmark	✓	✓
Germany	✓	✓
France	✓	✓
Greece	✓	✓
Great Britain	✓	✓
Italy	✓	✓
Luxemburg	✓	✓
The Netherlands	✓	✓
Austria	✓	✓
Portugal	✓	✓
Switzerland	✓	✓
Spain	✓	✓
South Africa	-	-
Czech Republic	✓	✓

✓ SMA product is available

- SMA product is not available

Sunny Boy Smart Energy, Sunny Boy Storage and Sunny Island

Country	Sunny Boy Smart Energy	Sunny Boy Storage 2.5	Sunny Boy Storage 3.7 / 5.0 / 6.0	Sunny Island 4.4M / 6.0H / 8.0H
Australia	✓	✓	✓	-
Belgium	✓	✓	✓	✓
Denmark	-	-	-	-
Germany	✓	✓	✓	✓
France	-	-	✓	✓
Greece	-	-	-	-
Great Britain	✓	✓	✓	-

Country	Sunny Boy Smart Energy	Sunny Boy Storage 2.5	Sunny Boy Storage 3.7 / 5.0 / 6.0	Sunny Island 4.4M / 6.0H / 8.0H
Italy	✓	✓	✓	-
Luxemburg	-	-	✓	-
The Netherlands	✓	-	✓	-
Austria	-	✓	✓	-
Portugal	-	-	✓	✓
Switzerland	-	✓	✓	✓
Spain	-	-	✓	-
South Africa	-	✓	✓	-
Czech Republic	-	-	-	-

✓ SMA product is available - SMA product is not available

Additional information, e.g. on the availability of PV inverters, is available at www.SMA-Solar.com.

11.2 Planning Mounting Locations

The products within the SMA Smart Home system solution have requirements with regard to their mounting locations:

- Sunny Home Manager 2.0
- SMA radio-controlled sockets
- SMA Energy Meter
- Sunny Boy 3600 / 5000 Smart Energy
- Sunny Island 4.4M / 6.0H / 8.0H with battery and battery fuse
- Sunny Boy Storage with battery

The following points should be considered as early as the planning stage:

- The minimum clearances to walls, objects, SMA products or other technical devices must be complied with.
- The ambient conditions at the planned deployment sites must meet the requirements the individual products place on the mounting locations.
- The maximum cable routes and radio ranges between the listed SMA products and to other devices must be feasible.
- The cable cross-sections and conductor materials of the planned cables must meet the requirements of the listed products.
- SMA Integrated Storage System: The Sunny Boy Smart Energy with the Battery Pack Smart Energy must only be operated at an ambient temperature of 0°C to 40°C and a relative humidity of 5% to 95%.
- SMA Flexible Storage System:

The battery room must meet the requirements of the battery manufacturer.

A battery fuse must be installed between the DC connection of the Sunny Island and the battery (for the requirements for the battery fuse see the Sunny Island operating manual).

Links to additional information can be found at www.SMA-Solar.com:

Energy management system	Document title	Document type
Sunny Home Manager 2.0	Sunny Home Manager	Operating manual
SMA Integrated Storage System	Sunny Home Manager	Operating manual
	Sunny Boy 3600 / 5000 Smart Energy Battery Pack Smart Energy	Operating manual
	SMA Energy Meter	Installation manual
SMA Flexible Storage System*	Sunny Home Manager	Operating manual
	Sunny Island 4.4M / 6.0H / 8.0H	Operating manual
	Sunny Boy Storage 2.5 / 3.7 / 5.0 / 6.0	Operating manual
	SMA Energy Meter	Installation manual

* The requirements for the mounting location of the PV inverters used are listed in the manuals for the PV inverters.

