

SOLAR'S MOST TRUSTED



INSTALLATION MANUAL REC 60-CELL MODULES

Installation instructions for all REC Peak Energy and REC TwinPeak 60-cell size solar panels certified according to IEC 61215 / 61730:

- REC Peak Energy Series / REC Peak Energy BLK Series
- REC TwinPeak Series / REC TwinPeak BLK Series
- REC TwinPeak 2 Series / REC TwinPeak 2 BLK Series
- REC TwinPeak 2 BLK2 Series
- REC TwinPeak 2S Mono Series

CONTENTS

| | |
|--|-----------|
| CONTENTS | 2 |
| List of figures | 2 |
| INTRODUCTION | 3 |
| SAFETY MEASURES | 4 |
| Safety in the working area | 4 |
| Panel handling | 4 |
| ELECTRICAL INSTALLATION | 5 |
| Electrical requirements | 5 |
| MECHANICAL INSTALLATION | 5 |
| Fire guidelines | 5 |
| Orientation | 5 |
| Environmental factors | 5 |
| PANEL INSTALLATION | 6 |
| Rail specifications | 6 |
| Clamp specifications | 6 |
| Mounting methods: REC Peak Energy & REC Peak Energy BLK Series panels | 7 |
| Mounting methods: REC TwinPeak & REC TwinPeak BLK Series panels | 8 |
| Mounting methods: REC TwinPeak 2, REC TwinPeak 2 BLK & REC TwinPeak 2 BLK2 Series panels | 9 |
| Drainage holes | 10 |
| Grounding | 10 |
| CONNECTIONS AND CONNECTORS | 11 |
| MAINTENANCE | 12 |
| Cleaning instructions | 12 |
| Recycling | 12 |
| Disposal of old electrical and electronic equipment | 12 |
| PANEL INFORMATION | 13 |
| Technical characteristics: REC Peak Energy Series & REC Peak Energy BLK Series | 13 |
| Technical characteristics: REC TwinPeak Series & REC TwinPeak BLK Series | 14 |
| Technical characteristics: REC TwinPeak 2 Series & REC TwinPeak 2 BLK Series | 15 |
| Technical characteristics: REC TwinPeak 2 BLK2 Series | 16 |
| ANNEX 1: INSTALLATIONS ON WATER PLATFORMS | 17 |
| EC DECLARATION OF CONFORMITY | 18 |
| DOCUMENT HISTORY | 19 |

LIST OF FIGURES

| | | | |
|--|---|---|----|
| Fig. 1: Example of rail cross-section | 6 | Fig. 15: Mounting holes: REC TwinPeak 2 | 9 |
| Fig. 2: Panel mounting: Rails clamped on long side of frame | 6 | Fig. 16: Mounting hole specifications: REC TwinPeak 2 | 9 |
| Fig. 3: Panel mounting: Rails clamped on short side of frame | 6 | Fig. 17: Mounting hole installation: REC TwinPeak 2 | 9 |
| Fig. 4: Clamp specifications: End and mid-clamps | 6 | Fig. 18: Drainage holes | 10 |
| Fig. 5: Clamping the frame to rail | 6 | Fig. 19: Grounding specifications | 10 |
| Fig. 6: Clamping Zones: REC Peak Energy Series | 7 | Fig. 20: Grounding holes | 10 |
| Fig. 7: Mounting holes: REC Peak Energy | 7 | Fig. 21: Connector mating matrix | 11 |
| Fig. 8: Mounting hole specifications: REC Peak Energy | 7 | Fig. 22: Minimum cable bend radius | 11 |
| Fig. 9: Mounting hole installation: REC Peak Energy | 7 | Fig. 23: Panel dimensions: REC Peak Energy Series | 13 |
| Fig. 10: Clamping Zones: REC TwinPeak Series | 8 | Fig. 24: Panel dimensions: REC TwinPeak Series | 14 |
| Fig. 11: Mounting holes: REC TwinPeak | 8 | Fig. 25: Panel dimensions: REC TwinPeak 2 Series | 15 |
| Fig. 12: Mounting hole specifications: REC TwinPeak | 8 | Fig. 26: Panel dimensions: REC TwinPeak 2 BLK2 Series | 16 |
| Fig. 13: Mounting hole installation: REC TwinPeak | 8 | Fig. 27: WEEE symbol | 12 |
| Fig. 14: Clamping Zones: REC TwinPeak 2 Series | 9 | | |

INTRODUCTION

Thank you for choosing REC photovoltaic panels for your installation. REC solar panels are ideal for delivering long-lasting and reliable power output. They have been created through intelligent design and are manufactured to the highest quality and environmental standards. With correct installation and maintenance, REC panels will provide clean, renewable energy for many years.

Please read this entire manual carefully. It contains critical information on safety, as well as detailed instructions for the installation, operation and maintenance of the panels. Failure to follow these procedures will invalidate the warranty (available to download via www.recgroup.com/warranty). Review all instructions and safety notes before working on the system. Failure to do so may lead to injury or damage to property.

HOW TO USE THIS MANUAL

This installation manual describes the procedures for the terrestrial mounting of all REC solar panels of a '60-cell size' of the REC Peak Energy and REC TwinPeak product families certified according to IEC 61215 and IEC 61730 standards in a photovoltaic array. This includes all product variants (as indicated by the use of the appropriate suffix in the panel name) with a white or black backsheet, a silver or black frame, and/or square or rectangular monocrystalline or multicrystalline cells. The installed panel is considered to be in compliance with IEC 61215 and IEC 61730 only when mounted in the manner specified by this installation manual. Note that any panel without a frame (laminated) is not considered to comply with the requirements of IEC 61215 and IEC 61730 unless mechanically installed with hardware that has been tested and evaluated with the panel under this standard or by a field inspection certifying that the installed panel complies with the requirements of IEC 61215 and IEC 61730.

Except where specifically stated, the information and drawings within this manual refer to all frame, backsheet, and cell types; the illustrations are meant to be a generic representation of the instructions detailed in the text regardless of the color depicted. Review this entire manual before commencing installation of the panels and ensure you are working from the latest version. Throughout the manual, you will see icons which highlight important information or notes:



Indicates potential for damage to the array, property or personal safety.



Indicates important notes on best practice to help with the installation.

For further information on installation procedures, please call your panel distributor or contact your local REC Solar office. Details can be found at: www.recgroup.com/contact.

YOUR RESPONSIBILITY AS AN INSTALLER

Installers are responsible for the safe and effective installation and operation of the photovoltaic system and for adhering to all applicable local and national standards and regulations. Prior to installation, check all current regulations and permits concerning solar installations and ensure all local directives are observed. Furthermore, installers are responsible for the following points:

- Ensuring the REC panels are in a suitable condition for use and appropriate for the particular installation and environment,
- Using only parts that comply with the specifications set out in this manual,
- Ensuring a safe installation of all aspects of the electrical array.



All equipment should be properly maintained and inspected prior to use.



As this installation manual contains installation instructions for a number of different product variants, ensure you follow the instructions given for the correct product where specified.

SUPPORT

Do not attempt to install REC solar panels when you are unsure of the procedure or suitability. For questions or guidance with your installation, please call your distributor or contact your REC sales office, which can be found at: www.recgroup.com/contacts.

LIABILITY DISCLAIMER

REC SOLAR PTE. LTD. accepts no liability for the usability and functionality of its photovoltaic panels if the instructions in this guide are not observed. Since compliance with this guide and the conditions and methods of installation, operation, use and maintenance of the panels are not checked or monitored by REC SOLAR PTE. LTD., REC SOLAR PTE. LTD. accepts no liability for damage arising from improper application or incorrect installation, operation or maintenance. This does not apply to damages due to a panel fault, in cases of loss of life, bodily injury or damage to health or in the event of a grossly negligent breach of obligations on the part of REC SOLAR PTE. LTD. and/or in the event of an intentional or grossly negligent breach of obligations by a legal representative or vicarious agent. REC reserves the right to make changes or amendments to this manual at any time, without prior notice.

This document may be produced in different languages. If there is any conflict, the English language version shall be definitive.

LIMITED WARRANTY

The REC Limited Warranty is available to download from www.recgroup.com/warranty. Ignoring any of the instructions in this manual may be classed as improper installation or use and invalidate the Warranty Terms and Conditions. If you have any questions about installation and the Warranty validity, please contact REC's technical support.



Caution: Only qualified personnel should perform work on photovoltaic systems such as installation, commissioning, maintenance and repairs. Be sure to follow the safety instructions for all system components. Ensure relevant local codes and regulations for health and safety and accident prevention are observed.

SAFETY MEASURES

Installers are responsible for the safe and effective installation and operation of the system and for adhering to all applicable local and national standards and regulations. All relevant local codes and regulations should be referred to and observed as well as regulations on working at heights and fall protection.

SAFETY IN THE WORKING AREA

i) Safety in the working area

Installation of REC solar panels may involve working on rooftops or raised platforms. Ensure all local regulations regarding working at heights are followed. Before beginning work on a photovoltaic system, ensure all working surfaces are structurally sound and capable of bearing the weight of employees and required equipment.

 **Remember to isolate the system from the grid before carrying out any maintenance or repair work.**

ii) Preventing current generation

To prevent the panels automatically generating current (electricity) when exposed to light, shield the system with a non-transparent cover during installation, maintenance or repair work.

iii) Specific hazards of DC electricity

Solar panels generate direct current (DC). Once current is flowing, breaking or opening a DC connection (e.g., disconnecting two panels) can cause an electrical arc. Unlike low voltage AC wiring, DC arcs are not self-extinguishing. They are potentially lethal burn and fire hazards:

- Follow panel and inverter manufacturers' installation, handling and operating instructions,
- Remove/open the inverter AC fuse/circuit breaker before disconnecting from the public grid,
- Switch off or disconnect the inverter and wait for the time specified by the manufacturer before commencing work. High-voltage components need sufficient time to discharge.

iv) Safety requirements

The voltage produced by a single panel and panels connected in series (voltages added together) or in parallel (currents added together) can be dangerous. Although the fully insulated plug contacts on the panel's output cables provide touch-safe protection, the following points must be observed during handling to avoid the risk of sparking, fire hazards, burns and lethal electric shocks:

- Exercise extreme caution when wiring panels and look out for damaged or dirty cables etc,
- Never insert metallic or other conductive objects into plugs or sockets,
- Ensure that all electrical connections are completely dry before assembly,
- Keep all materials, tools, and working conditions dry and tidy,
- Use appropriate safety equipment e.g., non-slip footwear, insulated gloves and insulated tools,
- Solar panels produce current when exposed to sunlight. Do not connect the system to the inverter during solar exposure.

PANEL HANDLING

To avoid damage to the solar cells and other components, all REC solar panels should be handled with care and protected from damage at all times. All warnings and instructions on the packaging should be observed. Follow these guidelines when unpacking, transporting or storing panels:

- Record the serial numbers prior to installation and note the information in the system documentation,
- Carry the panels using both hands and do not use the junction box as a grip,
- Do not allow the panels to sag or bow under their own weight when being carried,
- Do not subject panels to loads or stresses, e.g., leaning on them or through the placing of weight on them,
- Do not stand on the panels,
- Avoid dropping the panels as any damage caused may be unseen,
- Keep all electrical contacts clean and dry,
- Store panels in a dry and properly ventilated room,
- Do not apply force to the backsheet,
- Avoid using sharp or pointed objects if panels require marking,
- Never apply paints, adhesives or detergents to the back of the laminate,
- Do not use any solar panel that is damaged or been tampered with,
- Never attempt to disassemble, modify, or adapt the panels or labels in any way as this will void the warranty.

 **Do not use a panel which is broken or damaged. If the panel front glass is broken or laminate back sheet is damaged, it can expose personnel to hazardous voltages.**

ELECTRICAL INSTALLATION

ELECTRICAL REQUIREMENTS

i) Application Class

REC solar panels are rated for use in Electrical Application Safety Class II; at hazardous levels of voltage (>35V), current(>8A) and power (>240W) where general contact access is anticipated (panels qualified for safety through IEC 61730-1 and -2).

ii) System Requirements

REC solar panels are only for use where they meet the specific technical requirements of the complete system. Ensure other components will not cause mechanical or electrical damage to the panels. Only panels of the same type and power class should be connected.

iii) String configuration

When using string configuration, plan and execute it according to the inverter manufacturer's instructions. The number of panels connected to an inverter must be within the inverter voltage limits and operating range. Do not exceed the total system voltage permitted by the manufacturer, nor under any circumstance exceed the maximum system voltage as stated in the technical specifications for the product at the rear of this manual. The maximum system fuse rating and the maximum reverse current for each panel can be found in the technical specifications for the product at the rear of this manual.

iv) String connection

Panels connected in series must have the same ampere rating. The maximum number of panels that can be connected in series or parallel depends upon system design, type of inverter and environmental conditions. Panel and string configuration must correspond to the specifications of other system components e.g., inverter. Refer to the reverse current rating of the panel as indicated in the Technical Characteristics section to the rear of this manual or on the panel datasheet.

v) Wiring layout

To minimize voltage surges (e.g., indirect lightning strikes), cables of the same string must be bundled together so loops are as small as possible. String configurations must be checked before commissioning. If open circuit voltage (V_{oc}) and short circuit current (I_{sc}) deviate from specification, this may indicate a configuration fault. Correct DC polarity must be observed at all times.

vi) Electrical Ratings

Electrical ratings are within a specific tolerance of measured values at Standard Test Conditions (STC) as given in the Technical Characteristics for each panel at the rear of this manual. Allow for increased panel output as a result of conditions different to STC by multiplying the I_{sc} and V_{oc} values of the solar panel by 1.25 (or according to local regulations) for electrical system installation.

MECHANICAL INSTALLATION

FIRE GUIDELINES

REC solar panels have a Class C fire classification. Utilize the following fire safety guidelines when installing REC solar panels:

- Check with all relevant local authorities for fire safety requirements for any building or structure on to which the panels will be installed,
- The system design must ensure that it can be easily accessed in the event of a building fire,
- Check with relevant authorities for applicable regulations concerning setbacks or other placement restrictions that may apply for roof-mounted arrays,
- The use of DC ground fault interrupters is recommended. This may also be required by local and national codes,
- All electrical appliances are a fire risk. The panel must be mounted over a fire retardant roof covering rated for the application and a distance of 40 mm between the panel and the mounting surface, allowing free circulation of air beneath the panels must be respected at all times.

ORIENTATION

The optimal mounting position of panels results in the sun's rays falling perpendicular (i.e., at 90°) to the surface. To maximize system output, panels should be installed at the optimum orientation and tilt angle. The specifics of this depend on location and can be calculated by a qualified system designer. All panels in a string should, wherever possible, have the same orientation and tilt to ensure the system does not underperform due to mismatched outputs.



Dependent on local conditions, a lower angle of installation will potentially increase the requirement for regular cleaning.



The solar panels must not be exposed to artificially concentrated light.

ENVIRONMENTAL FACTORS

REC solar panels are designed to provide decades of durable and stable output in installations up to 2000 m above sea level. Ambient operating temperatures must be between -40° and +85°C.



For further information regarding installations on water platforms, e.g., floating pontoons, see Annex 1 at the rear of this manual.

The panels are not suitable for installation in potentially hazardous locations nor should they be installed in the following locations:

- Near sources of flammable gas or vapor e.g., gas stations, gas containers or spray paint facilities,
- Near open flames,
- Under water or in water features,
- Where exposed to sulfur e.g., near sulfur springs or volcanoes,
- Where the panels may be exposed to harmful chemicals.



Ensure panels are not exposed to direct contact with salt water/spray.

PANEL INSTALLATION

REC solar panels are designed for capturing solar radiation and are not suitable for use as overhead or vertical glazing. The IP rating of the junction box provides a level of protection that allows panels to be mounted in any orientation (see product technical specifications for exact rating).

⚠ Panels must be installed so that the cells are not shaded as this will drastically reduce electrical output. If partial shading is inevitable at certain times of the day or year, it must be kept to an absolute minimum.

There are different options for securing REC solar panels depending on the design of the array. Ensure the mounting structure can withstand anticipated wind and snow loads. Mounting hardware is not supplied by REC. Follow the mounting hardware manufacturer's instructions and recommendations at all times.

⚠ Remove any labels or stickers that may be on the front of the panels and ensure no residue is left on the glass.

⚠ There must be a minimum clearance gap of 40 mm between the uppermost part of the installation surface (e.g., rooftop) and the lowest part of the panel (i.e., underside of module frame) to avoid any damage to the panel and to ensure sufficient airflow for cooling, helping to improve performance. The surface below the modules must be kept clear of any objects that may cause damage to the panel.

RAIL SPECIFICATIONS

REC solar panels are typically installed on a rail-based mounting system (fig. 1). When using mounting rails, ensure they run parallel to the frame (fig. 2) or across the module, underneath the frame (fig. 3) and that rails are positioned directly under the module clamping zones shown on the subsequent pages.

Fig. 1: Example of rail cross-section

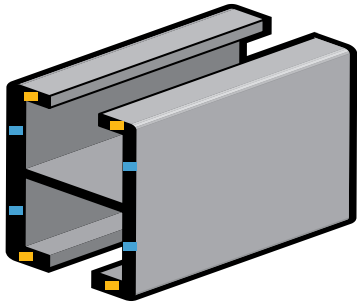

Fig. 2: Panel mounting: Rails clamped on long side of frame

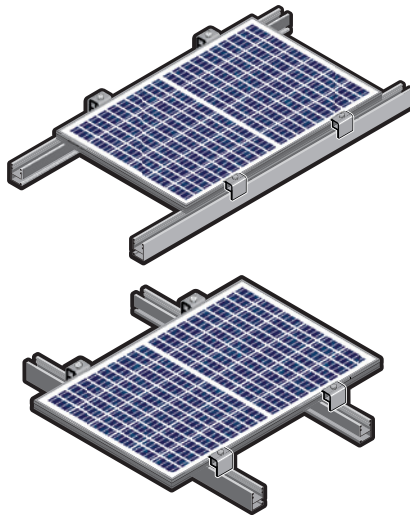
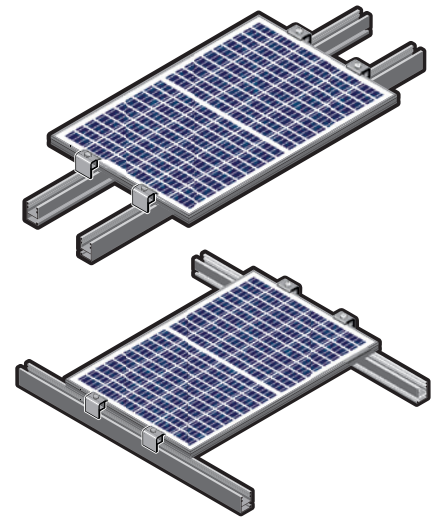

Fig. 3: Panel mounting: Rails clamped on short side of frame



CLAMP SPECIFICATIONS

Ensure the clamps used are rigid and suitable for the planned installation and expected system design loads.

- Minimum grip length of 40 mm, minimum grip depth of 5 mm (fig. 4). The grip area must not extend onto the panel frame and cause cell shading,
- Each panel must be clamped at a minimum of four points, as illustrated on the subsequent pages,
- Use appropriate bolted connections as per clamp manufacturer's instructions (fig. 5),
- Follow the clamp manufacturer's recommended applied torque to fasten the clamps.

Fig. 4: Clamp specifications: End and mid-clamps

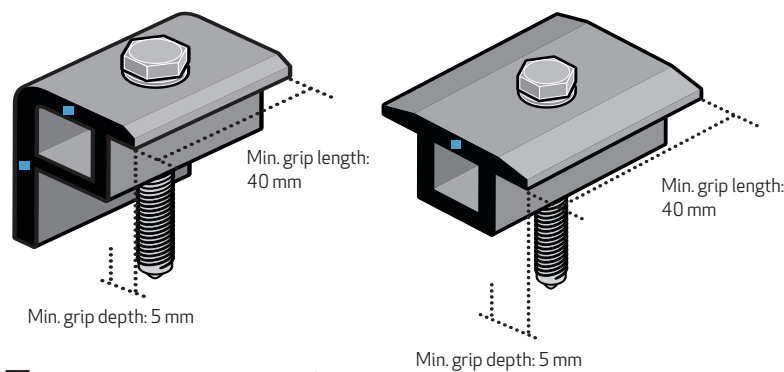
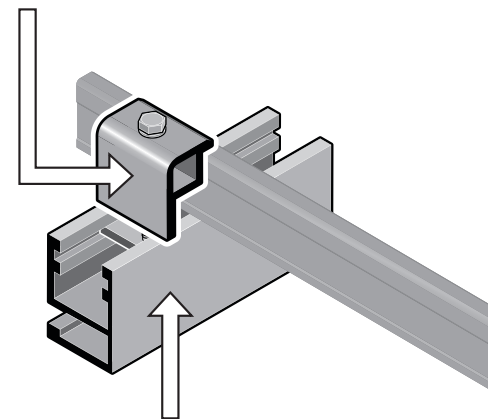

Fig. 5: Clamping the frame to rail



⚠ In areas of snow build-up panels can be subjected to forces in excess of the stated limit even when snow depth does not appear extreme, causing damage to the framework. If the installation is likely to be affected by this, further suitable panel support is recommended on the lower row of panels.

★ In the case of any questions regarding mounting systems, or if the mounting system to be used does not match any of the instructions shown in this installation manual, please contact REC for further support.

MOUNTING METHODS: REC PEAK ENERGY & REC PEAK ENERGY BLK SERIES PANELS

Mounting using clamps

REC Peak Energy solar panels can be secured using clamps on both the long and short sides of the panel where the clamps and rails are located within the constraints shown in fig. 6. Mounting utilizing clamps has been found to be in compliance with IEC 61215 & IEC 61730 requirements for up to a design load of 367 kg/m² (3600 Pa) downward force and 163 kg/m² (1600 Pa) upwards force according to the clamping position. Panels must be clamped in a minimum of four individual and non-adjacent clamping zones as shown below. Site-specific loads such as wind or snow which may exert forces in a different way need to be taken into consideration to ensure this limit is not exceeded.

- Clamps and rails must be fully located within the required colored clamping zone.
- Follow the clamp manufacturer's recommended applied torque to fasten the clamps.
- The distance between the end clamp and the end of the rail must be minimum 25 mm.

Fig. 6: Clamping Zones: REC Peak Energy Series

-  Clamping in the green zone (208-416 mm) is certified for downward design loads of 367 kg/m² (3600 Pa) & upward design loads of 163 kg/m² (1600 Pa).
-  Clamping in the yellow zone (0-208 mm) is certified for downward and upward design loads up to 163 kg/m² (1600 Pa).
-  Clamping in the red zone is not permitted (> 416 mm on long side, > 250 mm on short side).

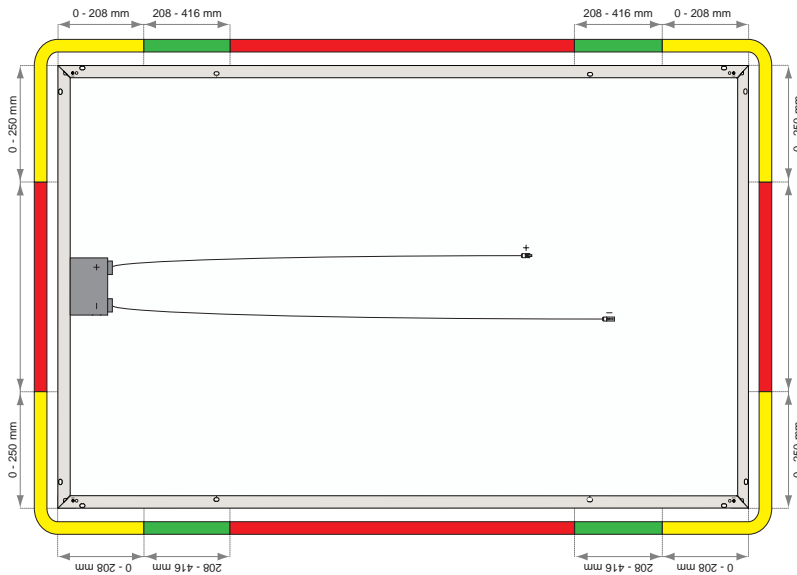

 **Each panel must be clamped at a minimum of four points. The minimum grip length of each clamp (fig. 4) and the rail must be fully located in the same color zone to be rated to that load value (fig. 6). If the panel is secured in two different zones, it is rated to the lower load value only.**

Mounting holes

REC Peak Energy panels have been certified for installation using the four elongated holes (11 x 6.6 mm) on the underside of the panel frame at a distance of 382.5 mm from the corner of the panel (fig. 7), utilizing rails and bolts matching the specifications in fig. 8. Installation of REC Peak Energy panels using mounting holes complies with IEC 61215 and IEC 61730 requirements for a maximum downward design load of 367 kg/m² (3600 Pa) and a maximum upward design load of 163 kg/m² (1600 Pa). When installing in this way, the frame and panel edge must be supported by two rails (figs. 1 & 2) of aluminium or galvanized steel suitable for the application and appropriate for the local environment. Observe the following procedures when using mounting holes:

- The mounting construction should be of aluminium or galvanized steel to avoid galvanic corrosion and be appropriate for the local environment.
- Additional electrical bonding to Ground is required for the support structure.
- All four mounting holes in the frame must be used (fig. 9).
- Tighten fastenings using a torque wrench according to the manufacturer's instructions.

Fig. 7: Mounting holes: REC Peak Energy

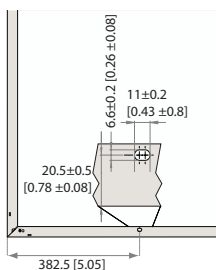
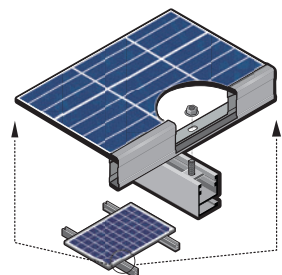

Fig. 8: Mounting hole specifications: REC Peak Energy

| Part Name | Material |
|-----------|------------------------------|
| Rail | 6105 - T5 aluminum extrusion |
| Bolt | M6 x 25 drop in T-stud kit |
| Nut | M6 flanged hex locking nut |

Fig. 9: Mounting hole installation: REC Peak Energy



 **The product warranty will be voided if additional holes are made in the frame. All fixing and fastening materials must be corrosion resistant.**

Slide in systems

REC Peak Energy panels may also be installed using slide-in systems. Such mounting systems must meet the same specifications regarding grip lengths and depths as clamps and be able to withstand the correct load pressures. When installing with slide-in systems, the drainage holes (fig. 22) must not be covered. For any questions regarding installation on such systems, please contact REC directly.



MOUNTING METHODS: REC TWINPEAK & REC TWINPEAK BLK SERIES PANELS

Mounting using clamps

REC TwinPeak solar panels can be secured using clamps on both the long and short sides of the panel where the clamps and rails are located within the constraints shown in fig. 10. Mounting utilizing clamps has been found to be in compliance with IEC 61215 & IEC 61730 requirements for up to a design load of 367 kg/m² (3600 Pa) downward force and 163 kg/m² (1600 Pa) upwards force according to the clamping position. Panels must be clamped in a minimum of four individual and non-adjacent clamping zones as shown below. Site-specific loads such as wind or snow which may exert forces in a different way need to be taken into consideration to ensure this limit is not exceeded.

- Clamps and rails must be fully located within the required colored clamping zone.
- Follow the clamp manufacturer's recommended applied torque to fasten the clamps.
- The distance between the end clamp and the end of the rail must be minimum 25 mm.

Fig. 10: Clamping Zones: REC TwinPeak Series

-  Clamping in the green zone (208-416 mm) is certified for downward design loads of 367 kg/m² (3600 Pa) & upward design loads of 163 kg/m² (1600 Pa).
-  Clamping in the yellow zone (0-208 mm) is certified for downward and upward design loads up to 163 kg/m² (1600 Pa).
-  Clamping in the red zone is not permitted (> 416 mm on long side, > 250 mm on short side).

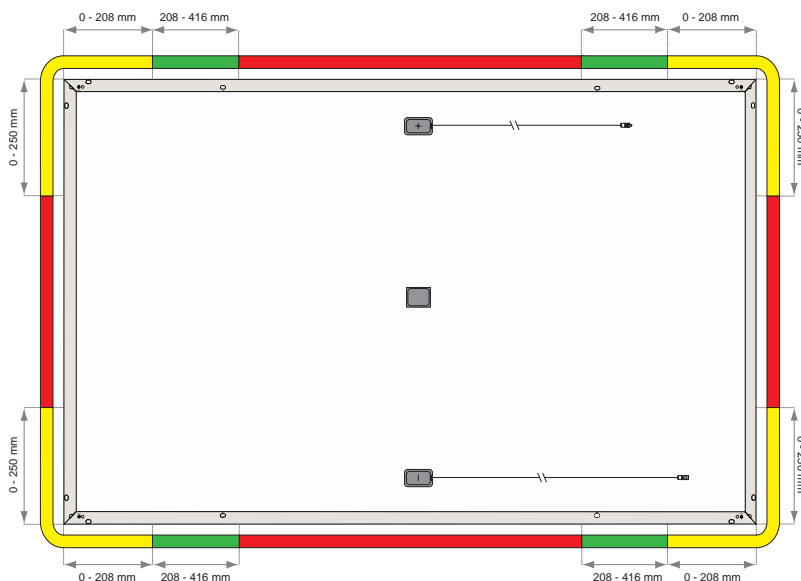

 **Each panel must be clamped at a minimum of four points. The minimum grip length of each clamp (fig. 4) and the rail must be fully located in the same color zone to be rated to that load value (fig. 10). If the panel is secured in two different zones, it is rated to the lower load value only.**

Mounting holes

REC TwinPeak panels have been certified for installation using the four elongated holes (11 x 6.6 mm) on the underside of the panel frame at a distance of 382.5 mm from the corner of the panel (fig. 11), utilizing rails and bolts matching the specifications in fig. 8. Installation of REC TwinPeak panels using mounting holes complies with IEC 61215 and IEC 61730 requirements for a maximum downward design load of 367 kg/m² (3600 Pa) and a maximum upward design load of 163 kg/m² (1600 Pa). When installing in this way, the frame and panel edge must be supported by two rails (figs. 1 & 2) of aluminium or galvanized steel suitable for the application and appropriate for the local environment. Observe the following procedures when using mounting holes:

- The mounting construction should be of aluminium or galvanized steel to avoid galvanic corrosion and be appropriate for the local environment.
- Additional electrical bonding to Ground is required for the support structure.
- All four mounting holes in the frame must be used (fig. 13).
- Tighten fastenings using a torque wrench according to the manufacturer's instructions.

Fig. 11: Mounting holes: REC TwinPeak

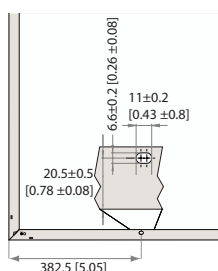
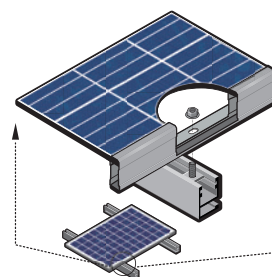

Fig. 12: Mounting hole specifications: REC TwinPeak

| Part Name | Material |
|-----------|------------------------------|
| Rail | 6105 - T5 aluminum extrusion |
| Bolt | M6 x 25 drop in T-stud kit |
| Nut | M6 flanged hex locking nut |

Fig. 13: Mounting hole installation: REC TwinPeak



 **The product warranty will be voided if additional holes are made in the frame. All fixing and fastening materials must be corrosion resistant.**

Slide in systems

REC TwinPeak panels may also be installed using slide-in systems. Such mounting systems must meet the same specifications regarding grip lengths and depths as clamps and be able to withstand the correct load pressures. When installing with slide-in systems, the drainage holes (fig. 22) must not be covered. For any questions regarding installation on such systems, please contact REC directly.



MOUNTING METHODS: REC TWINPEAK 2, REC TWINPEAK 2 BLK & REC TWINPEAK 2 BLK2 SERIES PANELS

Mounting using clamps

REC TwinPeak 2 solar panels can be secured using clamps on both the long and short sides of the panel where the clamps and rails are located within the constraints shown in fig. 14. Mounting utilizing clamps has been found to be in compliance with IEC 61215 & IEC 61730 requirements for up to a design load of 367 kg/m² (3600 Pa) downward force and 163 kg/m² (1600 Pa) upwards force according to the clamping position. Panels must be clamped in a minimum of four individual and non-adjacent clamping zones as shown below. Site-specific loads such as wind or snow which may exert forces in a different way need to be taken into consideration to ensure this limit is not exceeded.

- Clamps and rails must be fully located within the required colored clamping zone.
- Follow the clamp manufacturer's recommended applied torque to fasten the clamps.
- The distance between the end clamp and the end of the rail must be minimum 25 mm.

Fig. 14: Clamping Zones: REC TwinPeak 2 Series

-  Clamping in the green zone (208-416 mm) is certified for downward design loads of 367 kg/m² (3600 Pa) & upward design loads of 163 kg/m² (1600 Pa).
-  Clamping in the yellow zone (0-208 mm) is certified for downward and upward design loads up to 163 kg/m² (1600 Pa).
-  Clamping in the red zone is not permitted (> 416 mm on long side, > 250 mm on short side).

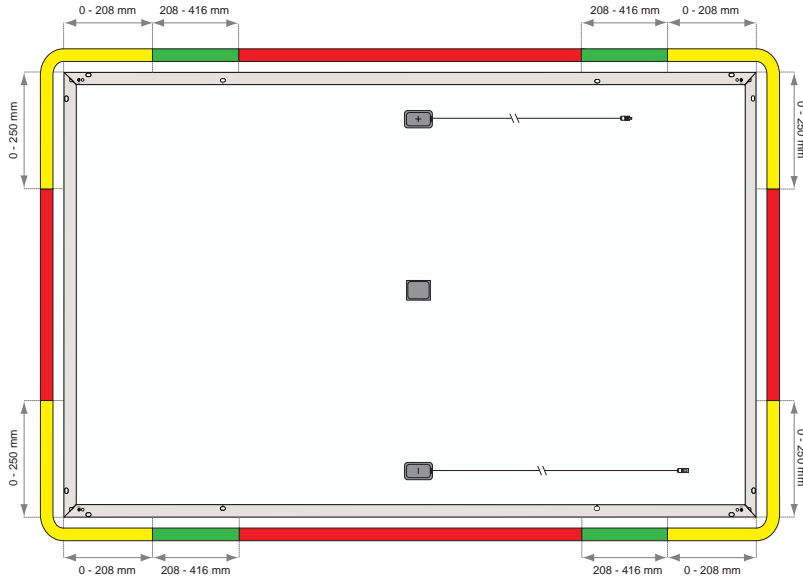

 **Each panel must be clamped at a minimum of four points. The minimum grip length of each clamp (fig. 4) and the rail must be fully located in the same color zone to be rated to that load value (fig. 14). If the panel is secured in two different zones, it is rated to the lower load value only.**

Mounting holes

REC TwinPeak 2 panels have been certified for installation using the four elongated holes (11 x 6.6 mm) on the underside of the panel frame at a distance of 382.5 mm from the corner of the panel (fig. 15), utilizing rails and bolts matching the specifications in fig. 16. Installation of REC TwinPeak 2 panels using mounting holes complies with IEC 61215 and IEC 61730 requirements for a maximum downward design load of 367 kg/m² (3600 Pa) and a maximum upward design load of 163 kg/m² (1600 Pa). When installing in this way, the frame and panel edge must be supported by two rails (figs. 1 & 2) of aluminium or galvanized steel suitable for the application and appropriate for the local environment. Observe the following procedures when using mounting holes:

- The mounting construction should be of aluminium or galvanized steel to avoid galvanic corrosion and be appropriate for the local environment.
- Additional electrical bonding to Ground is required for the support structure.
- All four mounting holes in the frame must be used (fig. 17).
- Tighten fastenings using a torque wrench according to the manufacturer's instructions.

Fig. 15: Mounting holes: REC TwinPeak 2

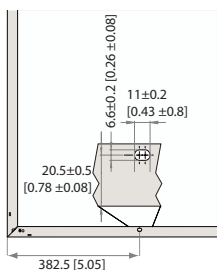
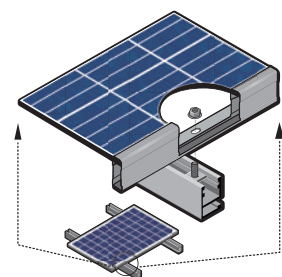

Fig. 16: Mounting hole specifications: REC TwinPeak 2

| Part Name | Material |
|-----------|------------------------------|
| Rail | 6105 - T5 aluminum extrusion |
| Bolt | M6 x 25 drop in T-stud kit |
| Nut | M6 flanged hex locking nut |

Fig. 17: Mounting hole installation: REC TwinPeak 2



 **The product warranty will be voided if additional holes are made in the frame. All fixing and fastening materials must be corrosion resistant.**

Slide in systems

REC TwinPeak 2 panels may also be installed using slide-in systems. Such mounting systems must meet the same specifications regarding grip lengths and depths as clamps and be able to withstand the correct load pressures. When installing with slide-in systems, the drainage holes (fig. 22) must not be covered. For any questions regarding installation on such systems, please contact REC directly.

DRAINAGE HOLES

Each corner of the REC panel frame has small drainage holes that allow water caused by rain, condensation, snow melt, cleaning or any other process to exit the frame easily and to minimize damage caused by freezing and thawing (fig. 18). These holes must not be used for mounting the panel.

Fig. 18: Drainage holes

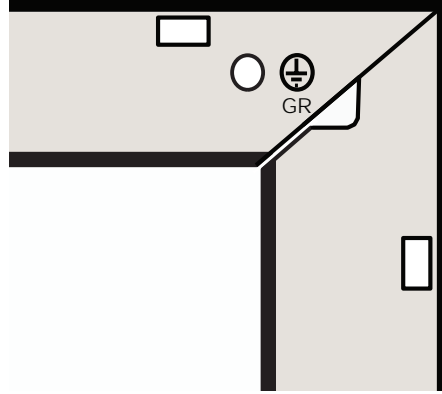

! To enable effective drainage and ensure there is no damage to the module, the drainage holes must remain fully open and enable water egress during and after installation.

★ The shape and dimensions of the drainage holes may vary slightly from the above image depending on product and/or frame design.

GROUNDING

Local regulations may require grounding of the panels. Check all applicable requirements before beginning installation. Where grounding is necessary, it must be done using an electrical connection from the panel frame and as per the specifications in fig. 19:

- Suitable grounding lugs must be used.
- Attach grounds to the grounding holes in the panel frames.
- Fix lug to the frame using a star washer and lock nut, ensuring a conductive connection (fig. 20).
- Place the star washer between the frame and the nut, using a 5 mm diameter stainless steel bolt and locking nut to mount the lug to the panel frame and tighten according to the manufacturer's recommended torque

! Where common grounding hardware (nuts, bolts, star washers, split-ring lock washers, flat washers and the like) are used to attach a grounding device, the attachment must be made in conformance with the grounding device manufacturer's instructions.

★ To avoid galvanic corrosion, stainless steel fastening materials are preferred, however galvanized or hot dipped zinc plated fasteners are equally suitable.

★ Negative grounding of the modules is not required.

Fig. 19: Grounding specifications

| Cross section [mm ²] | Type | Torque [Nm] |
|----------------------------------|----------------|-------------|
| 13 - 21.2 | Stranded | 3.9 |
| 8.4 | Stranded | 3.4 |
| 2.1 - 5.3 | Stranded/Solid | 2.8 |

Fig. 20: Grounding holes

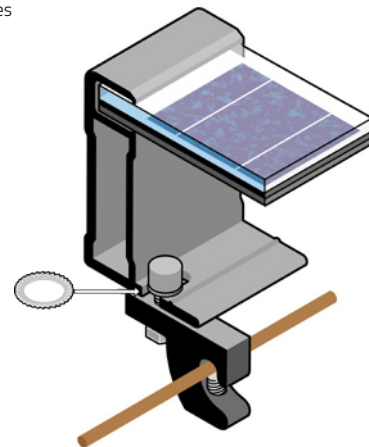

CONNECTIONS AND CONNECTORS

The connectors on REC solar panels have an IP rating as indicated in the product technical specifications which is only valid when correctly connected. All connectors and cables must be secure and tight as well as electrically and mechanically sound. UV-resistant cables and connectors approved for outdoor use must be used. Conductor gauge must be chosen to ensure DC power losses (voltage drop) are kept to a minimum (<1%). Observe all local regulations when selecting cables. For string connections, use minimum 4 mm² or copper wires insulated for a maximum operating temperature of 90°C. Secure cables using UV-resistant cable ties or other device. Loose and unsecured cables must be protected from damage (e.g., mechanical, abrasion, sharp objects, animals). Avoid exposing cables to direct sunlight and permanent tension.

In order to ensure durable and safe connections between panels and BOS equipment, the following instructions must be followed in order to protect the electrical connections from the elements. More detailed information is given in the *Guide to Best Practice - Connections and Connectors* which can be found via the REC online Download Center (www.recgroup.com/downloads).

Safety is paramount when working with electrical connectors. Ensure that any installation work is not carried out on live or load-carrying parts. Connections must not be disconnected under load and the system must be isolated from the grid before carrying out any maintenance or repair work.

CONNECTORS

To ensure connector compatibility and reduce the potential for damage to the modules and the wider installation, REC recommends that mated connectors are from the same manufacturer and of the same connector type. REC factory-installed connectors are of the 'MC4 type' design, therefore REC only permits the mating of factory-installed connectors to connectors of the same manufacturer and type and to Stäubli MC4 connectors as shown in the table below (fig. 21):

Fig. 21: Connector mating matrix

| Connector 1 | + | Connector 2 | Permitted? |
|-----------------------|---|-----------------------|------------|
| REC Factory-Installed | + | Stäubli MC4 | ✓ |
| REC Factory-Installed | + | REC Factory-Installed | ✓ |
| REC Factory-Installed | + | Any other connector | ✗ |

★ **Some countries and/or regions have specific regulations regarding the mating of connectors. Installers are responsible for ensuring the compliancy of the system with such local regulations.**

⚠ **The cutting of cables is only permitted in order to replace a factory-installed connector with another brand of connector to ensure 'like-for-like' mating when connected to a non-REC external device. All other changes are prohibited and will invalidate the REC warranty. The connector replacement procedure must be carried out by the installer correctly and according to the replacement connector manufacturer's instructions. The selected replacement connector must also fulfil all relevant technical specifications and be certified according to applicable standards (e.g., EN 50521, IEC 62852 or UL 6703) so as to ensure they are fit for purpose and safety. The REC warranty does not extend to cover any fault traceable to the replaced connectors.**

- The secure connection of connectors is identified by a firm click once inserted.
- Use of any chemicals or lubricants on the connectors or contacts may only be carried out in line with the connector manufacturer's instructions.

⚠ **Any other modification to the panel is prohibited, including the opening of the junction box, unless explicitly authorized by REC. Doing so will invalidate the warranty.**

PROTECTING THE CABLES

- To prevent stress on the junction box casing, ensure the cable exits the junction box in a straight line before any bend in the cable.
- The cables on REC solar panels have a minimum bending radius of 30 mm to avoid damage to the insulation (Fig. 22).

Fig. 22: Minimum cable bend radius

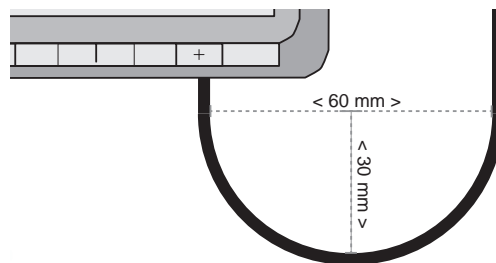

- Ensure cables do not hang loose where they may be damaged through friction or stress, e.g., caused by wind or grazing animals.
- Shield connectors from falling or dropping water by locating them directly beneath a panel.
- Cables must be firmly secured to the structure, without over-tightening, as this can deform the cable insulation.

SECURING CABLES AND CONNECTORS

- When securing the connector, place it so that it has with sufficient air circulation all around. This allows the connector to dry effectively and avoids the risk of damage or degradation of the connection.
- Good practice is to secure the cable either side of the connectors, ensuring no stress is exerted on the connector casing or cable entry.

⚠ **To enable correct cooling and drying of the connectors, do not add extra protection to the connector, e.g., heat shrink, grease or tape.**

MAINTENANCE

CLEANING INSTRUCTIONS

REC solar panels have been designed for easy maintenance. The need for cleaning the solar panels will vary dependent on location, rainfall, air pollution levels and the angle of installation – the lower the angle of installation, the more cleaning will be required. 'Normal' rainfall will naturally clean the panels if installed at a sufficient angle. To optimize electrical output it is recommended to clean the panels when dirt can be seen on the glass surface.

★ **Panel cleaning should always be carried out when the panels are cool to avoid breakage through thermal shock, e.g., early morning.**

The build up of dirt on the panel surface over time may cause cell shading which will reduce power output or can even cause further damage. To clean either the front or rear of the panels, use only deionized water free from grit and physical contaminants, at ambient temperature and use a sponge, microfiber cloth or a soft brush to wipe away the dirt (rainwater, tap water or diluted alcohol may also be used as a secondary solution). For further cleaning a mild, biological and biodegradable washing-up liquid may be used.

When cleaning the panel, take care not to scratch the surface or introduce foreign elements that may cause damage. Ensure the water used is free from grit and physical contaminants that may damage the panel. Always rinse the panel with plenty of water. If soiling remains on the panel, repeat the cleaning process. If stains require more effort to be removed, Isopropyl alcohol of a concentration less than 10% may be used. Acid or Alkali detergent may not be used.

⚠ **Use of high pressure hoses or cleaners is not permitted as these may damage the panels, laminate or cells.**

Using a soft rubber squeegee, wipe the panel surface from the top downwards to remove any residual water from the panel glass. Panels can be left to dry in the air or wiped dry with a clean and soft cloth or chamois. Avoid putting pressure on the on the panel surface when drying, e.g., leaning or standing on it.

For more information on cleaning REC solar panels, consult the *REC Cleaning Information Sheet* which is available to download from the online REC Download Center www.recgroup.com/downloads. If in doubt at any time when cleaning the panels, stop and obtain professional advice.

SYSTEM INSPECTION

The system should be inspected regularly to ensure that:

- Fasteners are secure, tight and free from corrosion,
- Electrical connections are secure, tight, clean, and free of corrosion,
- The mechanical integrity of the cables is intact,
- Bonding points to ground are tight, secure and free from corrosion (which could break the continuity between the panels and ground).

RECYCLING

REC makes every effort to ensure panel packaging is kept to a minimum. The paper and cardboard packaging can be recycled and the protective wrapping and panel separating blocks are also recyclable in many areas. Recycle packaging and modules according to local guidelines and regulations.

DISPOSAL OF OLD ELECTRICAL AND ELECTRONIC EQUIPMENT

Modules should be recycled at the end of their useful life according to local guidelines and regulations. By ensuring REC solar panels are disposed of correctly, you will help prevent potential negative consequences for the environment and human health which could otherwise be caused by inappropriate waste treatment. The majority of the module components can be recycled.

For installations in the European Union, REC solar panels are subject to WEEE regulations. The symbol in fig. 23 as found on the label on the rear of the module indicates that this product shall not be treated as household waste and must be disposed of at an appropriate collection point for the recycling of electrical and electronic equipment. The recycling of the different components and materials will help to conserve natural resources.

Fig. 27: WEEE symbol



The European WEEE (Waste Electrical and Electronic Equipment) Directive regulates the correct recycling of electronic and electrical waste in all member states of the European Union (EU). For end-customers it is a free of charge disposal system, financed by the manufacturers and importers, where modules can be brought to a local recycling depot, or in the case of larger numbers, be picked up from site, as is the case with other electrical equipment, e.g., refrigerators or televisions. The extensive process steps for proper disposal are strictly regulated by the authorities and place no further obligations on the owner of the modules. For more information about the recycling of this product, please contact your local recycling authority or recycling center.

PANEL INFORMATION

TECHNICAL CHARACTERISTICS: REC PEAK ENERGY SERIES & REC PEAK ENERGY BLK SERIES

Fig. 23: Panel dimensions: REC Peak Energy Series

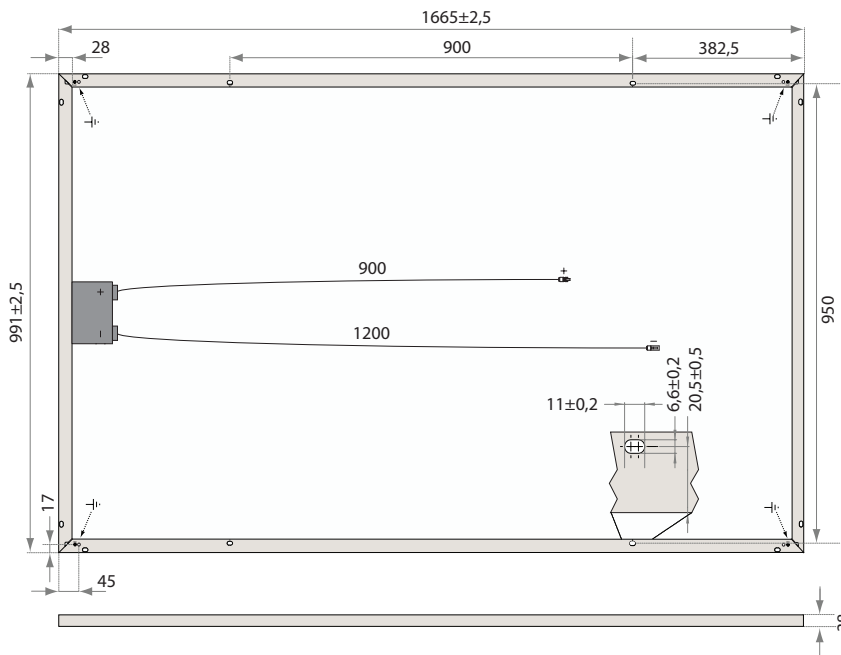

Measurements in mm [in]

ELECTRICAL DATA @ STC

Product code*: RECxxxPE

| | 250 | 255 | 260 | 265 | 270 | 275 |
|---------------------------------------|-------|-------|-------|-------|-------|-------|
| Nominal Power - P_{MPP} (Wp) | 250 | 255 | 260 | 265 | 270 | 275 |
| Watt Class Sorting - (W) | -0/+5 | -0/+5 | -0/+5 | -0/+5 | -0/+5 | -0/+5 |
| Nominal Power Voltage - V_{MPP} (V) | 30.2 | 30.5 | 30.7 | 30.9 | 31.2 | 31.5 |
| Nominal Power Current - I_{MPP} (A) | 8.30 | 8.42 | 8.50 | 8.58 | 8.66 | 8.74 |
| Open Circuit Voltage - V_{OC} (V) | 37.4 | 37.6 | 37.8 | 38.1 | 38.4 | 38.7 |
| Short Circuit Current - I_{SC} (A) | 8.86 | 8.95 | 9.01 | 9.08 | 9.18 | 9.25 |
| Panel Efficiency (%) | 15.2 | 15.5 | 15.8 | 16.1 | 16.4 | 16.7 |

Values at standard test conditions (STC: air mass AM1.5, irradiance 1000 W/m², temperature 25°C), based on a production spread with a tolerance of P_{MPP} , V_{OC} & I_{SC} ±3% within one watt class. At low irradiance of 200 W/m² at least 95.5% of the module efficiency of P_{MPP} @ STC will be achieved.
*Where xxx indicates the nominal power class (P_{MPP}) at STC indicated above, and can be followed by the suffix BLK for black framed modules.

ELECTRICAL DATA @ NMOT

Produkt code*: RECxxxPE

| | 183 | 187 | 190 | 193 | 196 | 202 |
|---------------------------------------|------|------|------|------|------|------|
| Nominal Power - P_{MPP} (Wp) | 183 | 187 | 190 | 193 | 196 | 202 |
| Nominal Power Voltage - V_{MPP} (V) | 27.8 | 28.0 | 28.2 | 28.4 | 28.6 | 28.8 |
| Nominal Power Current - I_{MPP} (A) | 6.58 | 6.68 | 6.74 | 6.80 | 6.86 | 7.02 |
| Open Circuit Voltage - V_{OC} (V) | 34.7 | 34.8 | 35.0 | 35.3 | 35.7 | 36.0 |
| Short Circuit Current - I_{SC} (A) | 7.11 | 7.18 | 7.23 | 7.29 | 7.35 | 7.40 |

Nominal module operating temperature (NMOT: air mass AM1.5, irradiance 800 W/m², temperature 20°C, windspeed 1 m/s).
*Where xxx indicates the nominal power class (P_{MPP}) at STC indicated above, and can be followed by the suffix BLK for black framed modules.

CERTIFICATIONS



IEC 61215, IEC 61730 & UL 1703; MCS 005, IEC 62804 (PID)
IEC 62716 (Ammonia Resistance), IEC 60068-2-68 (Blowing Sand)
IEC 61701 (Salt Mist level 6), UNI 8457/9174 (Class A), ISO 11925-2 (Class E)
ISO 9001:2015, ISO 14001:2004, OHSAS 18001:2007

takeaway take-e-way WEEE-compliant recycling scheme
FOR AN EASY WAY

WARRANTY

10 year product warranty
25 year linear power output warranty
(max. degradation in performance of 0.7% p.a.)
See warranty conditions for further details.

16.7% EFFICIENCY

10 YEAR PRODUCT WARRANTY

25 YEAR LINEAR POWER OUTPUT WARRANTY

GENERAL DATA

| | |
|---------------|---|
| Cell type: | 60 multicrystalline cells 3 strings of 20 cells in series |
| Glass: | 3.2 mm solar glass with anti-reflection surface treatment |
| Backsheet: | Highly resistant polyester |
| Frame: | Anodized aluminum (silver / black) |
| Junction box: | 3 bypass diodes, IP67 rated in accordance with IEC 62790 |
| Cable: | 4 mm ² solar cable, 0.9 m + 1.2 m in accordance with EN 50618 |
| Connectors: | Stäubli MC4 PV-KBT4/PV-KST4 (4 mm ²) Tonglin TL-Cable01S-FR (4 mm ²) in accordance with IEC 62852, IP68 only when connected |
| Origin: | Made in Singapore |

MAXIMUM RATINGS

| | |
|--------------------------|----------------------------------|
| Operational temperature: | -40 ... +85°C |
| Maximum system voltage: | 1000 V |
| Design load (+): snow | 367 kg/m ² (3600 Pa)* |
| Maximum test load (+): | 550 kg/m ² (5400 Pa) |
| Design load (-): wind | 163 kg/m ² (1600 Pa)* |
| Maximum test load (-): | 244 kg/m ² (2400 Pa) |
| Max series fuse rating: | 25 A |
| Max reverse current: | 25 A |

* Safety factor 1.5

TEMPERATURE RATINGS*

| | |
|--|---------------|
| Nominal Module Operating Temperature: | 45.7°C (±2°C) |
| Temperature coefficient of P_{MPP} : | -0.40 %/°C |
| Temperature coefficient of V_{OC} : | -0.27 %/°C |
| Temperature coefficient of I_{SC} : | 0.024 %/°C |

*The temperature coefficients stated are linear values

MECHANICAL DATA

| | |
|-------------|---------------------|
| Dimensions: | 1665 x 991 x 38 mm |
| Area: | 1.65 m ² |
| Weight: | 18 kg |

Specifications subject to change without notice.
Ref: NE-05-07-07 Rev. F 08.17

TECHNICAL CHARACTERISTICS: REC TWINPEAK SERIES & REC TWINPEAK BLK SERIES

Fig. 24: Panel dimensions: REC TwinPeak Series

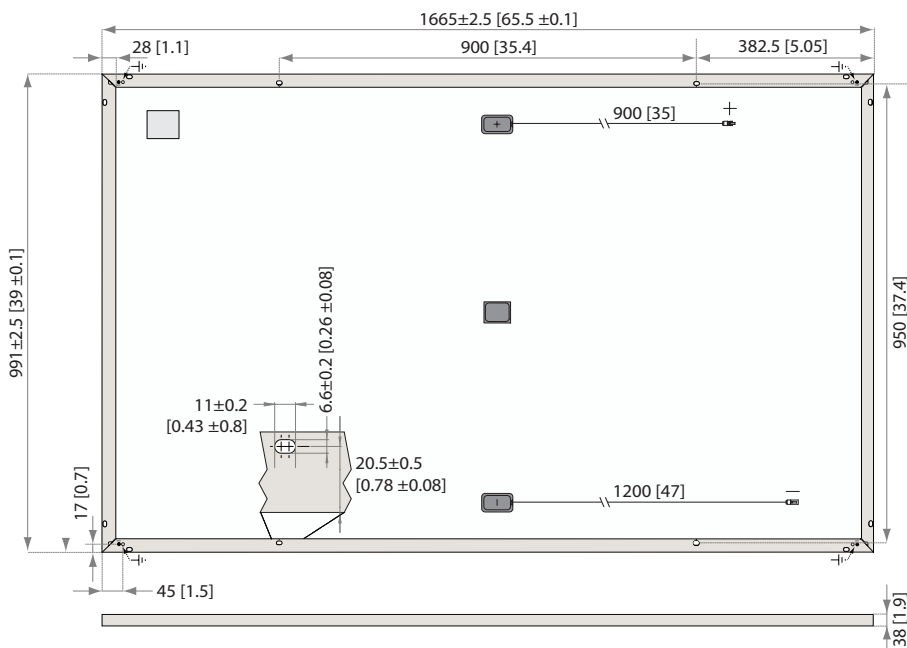

Measurements in mm [in]

| ELECTRICAL DATA @ STC | Product code*: RECxxxTP | | | | |
|---------------------------------------|-------------------------|-------|-------|-------|-------|
| Nominal Power - P_{MPP} (Wp) | 265 | 270 | 275 | 280 | 285 |
| Watt Class Sorting - (W) | -0/+5 | -0/+5 | -0/+5 | -0/+5 | -0/+5 |
| Nominal Power Voltage - V_{MPP} (V) | 31.1 | 31.2 | 31.4 | 31.9 | 32.1 |
| Nominal Power Current - I_{MPP} (A) | 8.53 | 8.66 | 8.76 | 8.78 | 8.90 |
| Open Circuit Voltage - V_{OC} (V) | 38.3 | 38.6 | 38.8 | 39.2 | 39.5 |
| Short Circuit Current - I_{SC} (A) | 9.21 | 9.29 | 9.40 | 9.44 | 9.54 |
| Panel Efficiency (%) | 16.1 | 16.4 | 16.7 | 17.0 | 17.3 |

Values at standard test conditions (STC: air mass AM1.5, irradiance 1000 W/m², temperature 25°C), based on a production spread with a tolerance of V_{OC} & I_{SC} \pm 3% within one watt class. At low irradiance of 200 W/m² at least 95% of the STC module efficiency will be achieved.
*Where xxx indicates the nominal power class (P_{MPP}) at STC indicated above, and can be followed by the suffix BLK for black framed modules.

| ELECTRICAL DATA @ NMOT | Product code*: RECxxxTP | | | | |
|---------------------------------------|-------------------------|------|------|------|------|
| Nominal Power - P_{MPP} (Wp) | 195 | 198 | 202 | 205 | 209 |
| Nominal Power Voltage - V_{MPP} (V) | 28.8 | 28.9 | 29.0 | 29.5 | 29.6 |
| Nominal Power Current - I_{MPP} (A) | 6.77 | 6.87 | 6.95 | 6.97 | 7.06 |
| Open Circuit Voltage - V_{OC} (V) | 35.2 | 35.5 | 35.7 | 36.1 | 36.3 |
| Short Circuit Current - I_{SC} (A) | 7.32 | 7.38 | 7.47 | 7.50 | 7.58 |

Nominal module operating temperature (NMOT: air mass AM1.5, irradiance 800 W/m², temperature 20°C, windspeed 1 m/s).
*Where xxx indicates the nominal power class (P_{MPP}) at STC indicated above, and can be followed by the suffix BLK for black framed modules.

CERTIFICATIONS

IEC 61215, IEC 61730 & UL 1703; MCS 005, IEC 62804 (PID)
IEC 62716 (Ammonia Resistance), IEC 60068-2-68 (Blowing Sand)
IEC 61701 (Salt Mist level 6), UNI 8457/9174 (Class A), ISO 11925-2 (Class E)
ISO 9001:2015, ISO 14001:2004, OHSAS 18001:2007

WARRANTY

10 year product warranty
25 year linear power output warranty (max. degradation in performance of 0.7% p.a.)
See warranty conditions for further details.

takeaway take-e-way WEEE-compliant recycling scheme

17.3% EFFICIENCY

10 YEAR PRODUCT WARRANTY

25 YEAR LINEAR POWER OUTPUT WARRANTY

GENERAL DATA

Cell type: 120 half-cut multicrystalline PERC cells
6 strings of 20 cells in series

Glass: 3.2 mm solar glass with anti-reflection surface treatment

Backsheet: Highly resistant polyester

Frame: Anodized aluminum (silver / black)

Junction box: 3-part, 3 bypass diodes, IP67 rated in accordance with IEC 62790

Cable: 4 mm² solar cable, 0.9 m + 1.2 m in accordance with EN 50618

Connectors: Stäubli MC4 PV-KBT4/PV-KST4 (4 mm²)
Tonglin TL-Cable01 (4 mm²) in accordance with IEC 62852, IP67 only when connected

Origin: Made in Singapore

MAXIMUM RATINGS

Operational temperature: -40 ... +85°C

Maximum system voltage: 1000 V

Design load (+): snow 367 kg/m² (3600 Pa)*
Maximum test load (+): 550 kg/m² (5400 Pa)

Design load (-): wind 163 kg/m² (1600 Pa)*
Maximum test load (-): 244 kg/m² (2400 Pa)

Max series fuse rating: 25 A

Max reverse current: 25 A

*Safety factor 1.5

TEMPERATURE RATINGS*

Nominal Module Operating Temperature: 44.6°C (\pm 2°C)

Temperature coefficient of P_{MPP} : -0.36 %/°C

Temperature coefficient of V_{OC} : -0.30 %/°C

Temperature coefficient of I_{SC} : 0.066 %/°C

*The temperature coefficients stated are linear values

MECHANICAL DATA

Dimensions: 1665 x 991 x 38 mm

Area: 1.65 m²

Weight: 18 kg

Specifications subject to change without notice. Ref: NE-05-07-02-01 Rev- J 07/17

TECHNICAL CHARACTERISTICS: REC TWINPEAK 2 SERIES & REC TWINPEAK 2 BLK SERIES

Fig. 25: Panel dimensions: REC TwinPeak 2 Series

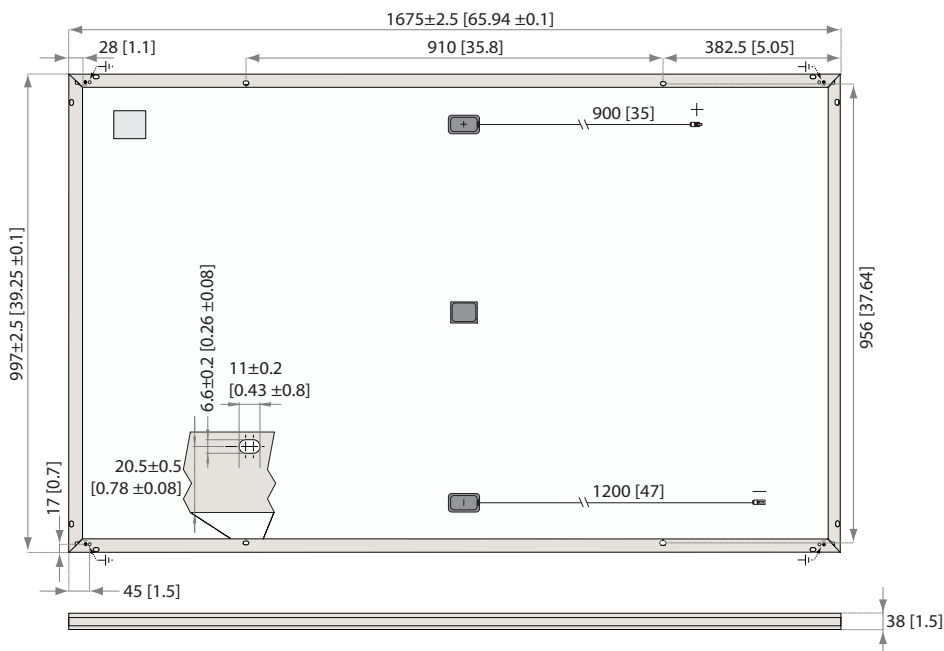

Measurements in mm [in]

| ELECTRICAL DATA @ STC | Product code*: RECxxxTP2 | | | | | |
|---------------------------------------|--------------------------|-------|-------|-------|-------|-------|
| Nominal Power - P_{MPP} (Wp) | 275 | 280 | 285 | 290 | 295 | 300 |
| Watt Class Sorting - (W) | -0/+5 | -0/+5 | -0/+5 | -0/+5 | -0/+5 | -0/+5 |
| Nominal Power Voltage - V_{MPP} (V) | 31.5 | 31.7 | 31.9 | 32.1 | 32.3 | 32.5 |
| Nominal Power Current - I_{MPP} (A) | 8.74 | 8.84 | 8.95 | 9.05 | 9.14 | 9.24 |
| Open Circuit Voltage - V_{OC} (V) | 38.2 | 38.4 | 38.6 | 38.8 | 39.0 | 39.2 |
| Short Circuit Current - I_{SC} (A) | 9.52 | 9.61 | 9.66 | 9.71 | 9.76 | 9.82 |
| Panel Efficiency (%) | 16.5 | 16.8 | 17.1 | 17.4 | 17.7 | 18.0 |

Values at standard test conditions (STC: air mass AM1.5, irradiance 1000 W/m², temperature 25°C), based on a production spread with a tolerance of V_{OC} & I_{SC} ±3% within one watt class. At a low irradiance of 200 W/m² at least 95% of the STC module efficiency will be achieved.
*Where xxx indicates the nominal power class (P_{MPP}) at STC indicated above, and can be followed by the suffix BLK for black framed modules.

| ELECTRICAL DATA @ NMOT | Product code*: RECxxxTP2 | | | | | |
|---------------------------------------|--------------------------|------|------|------|------|------|
| Nominal Power - P_{MPP} (Wp) | 206 | 210 | 214 | 218 | 223 | 226 |
| Nominal Power Voltage - V_{MPP} (V) | 29.2 | 29.4 | 29.6 | 29.8 | 30.0 | 30.1 |
| Nominal Power Current - I_{MPP} (A) | 7.07 | 7.15 | 7.24 | 7.32 | 7.43 | 7.51 |
| Open Circuit Voltage - V_{OC} (V) | 35.4 | 35.6 | 35.8 | 36.0 | 36.2 | 36.3 |
| Short Circuit Current - I_{SC} (A) | 7.52 | 7.59 | 7.68 | 7.75 | 7.85 | 7.91 |

Nominal module operating temperature (NMOT: air mass AM1.5, irradiance 800 W/m², temperature 20°C, windspeed 1 m/s).
*Where xxx indicates the nominal power class (P_{MPP}) at STC indicated above, and can be followed by the suffix BLK for black framed modules.

CERTIFICATIONS

IEC 61215, IEC 61730 & UL 1703; MCS 005, IEC 62804 (PID)
IEC 62716 (Ammonia Resistance), IEC 60068-2-68 (Blowing Sand)
IEC 61701 (Salt Mist level 6), UNI 8457/9174 (Class A), ISO 11925-2 (Class E)
ISO 9001:2015, ISO 14001:2004, OHSAS 18001:2007

WARRANTY

10 year product warranty
25 year linear power output warranty (max. degradation in performance of 0.7% p.a.)
See warranty conditions for further details.

takeaway take-e-way WEEE-compliant recycling scheme

18.0% EFFICIENCY
10 YEAR PRODUCT WARRANTY
25 YEAR LINEAR POWER OUTPUT WARRANTY

GENERAL DATA

Cell type: 120 half-cut multicrystalline PERC cells
6 strings of 20 cells in series
Glass: 3.2 mm solar glass with anti-reflection surface treatment
Backsheet: Highly resistant polyester polyolefin construction
Frame: Anodized aluminum (silver / black)
Junction box: 3-part, 3 bypass diodes, IP67 rated in accordance with IEC 62790
Cable: 4 mm² solar cable, 0.9 m + 1.2 m in accordance with EN 50618
Connectors: Stäubli MC4 PV-KBT4/PV-KST4 (4 mm²)
Tonglin TL-Cable01S-FR (4 mm²)
in accordance with IEC 62852, IP68 only when connected
Origin: Made in Singapore

MAXIMUM RATINGS

Operational temperature: -40 ... +85°C
Maximum system voltage: 1000 V
Design load (+): snow 367 kg/m² (3600 Pa)*
Maximum test load (+): 550 kg/m² (5400 Pa)
Design load (-): wind 163 kg/m² (1600 Pa)*
Maximum test load (-): 244 kg/m² (2400 Pa)
Max series fuse rating: 25 A
Max reverse current: 25 A
* Safety factor 1.5

TEMPERATURE RATINGS*

Nominal Module Operating Temperature: 44.6°C (±2°C)
Temperature coefficient of P_{MPP} : -0.36 %/°C
Temperature coefficient of V_{OC} : -0.30 %/°C
Temperature coefficient of I_{SC} : 0.066 %/°C
*The temperature coefficients stated are linear values

MECHANICAL DATA

Dimensions: 1675 x 997 x 38 mm
Area: 1.67 m²
Weight: 18.5 kg

Specifications subject to change without notice. Ref: NE-05-07-07 Rev- G 0817

TECHNICAL CHARACTERISTICS: REC TWINPEAK 2 BLK2 SERIES

Fig. 26: Panel dimensions: REC TwinPeak 2 BLK2 Series

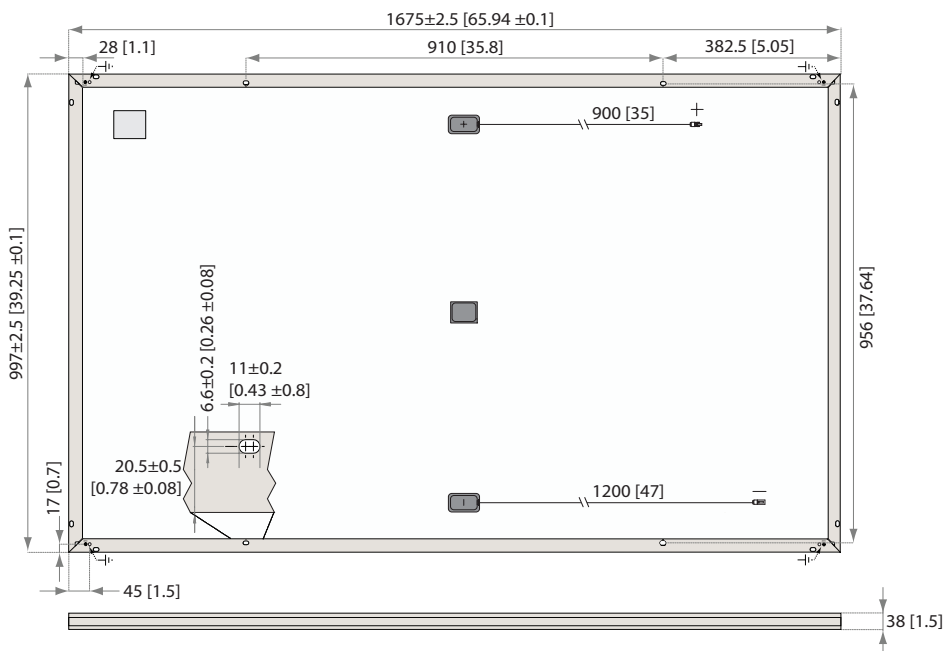

Measurements in mm [in]

ELECTRICAL DATA @ STC Product code*: RECxxxTP2 BLK2

| | | | |
|---------------------------------------|-------|-------|-------|
| Nominal Power - P_{MPP} (Wp) | 275 | 280 | 285 |
| Watt Class Sorting - (W) | -0/+5 | -0/+5 | -0/+5 |
| Nominal Power Voltage - V_{MPP} (V) | 31.6 | 31.8 | 32.0 |
| Nominal Power Current - I_{MPP} (A) | 8.71 | 8.82 | 8.92 |
| Open Circuit Voltage - V_{OC} (V) | 38.2 | 38.4 | 38.6 |
| Short Circuit Current - I_{SC} (A) | 9.28 | 9.39 | 9.49 |
| Panel Efficiency (%) | 16.5 | 16.8 | 17.1 |

Values at standard test conditions (STC: air mass AM1.5, irradiance 1000 W/m², temperature 25°C), based on a production spread with a tolerance of V_{OC} & I_{SC} ±3% within one watt class. At a low irradiance of 200 W/m² at least 95% of the STC module efficiency will be achieved.
*Where xxx indicates the nominal power class (P_{MPP}) at STC indicated above.

ELECTRICAL DATA @ NMOT Product code*: RECxxxTP2 BLK2

| | | | |
|---------------------------------------|------|------|------|
| Nominal Power - P_{MPP} (Wp) | 207 | 211 | 215 |
| Nominal Power Voltage - V_{MPP} (V) | 29.3 | 29.4 | 29.6 |
| Nominal Power Current - I_{MPP} (A) | 7.08 | 7.17 | 7.25 |
| Open Circuit Voltage - V_{OC} (V) | 35.4 | 35.6 | 35.7 |
| Short Circuit Current - I_{SC} (A) | 7.54 | 7.63 | 7.72 |

Nominal module operating temperature (NMOT: air mass AM1.5, irradiance 800 W/m², temperature 20°C, windspeed 1 m/s).

*Where xxx indicates the nominal power class (P_{MPP}) at STC indicated above.

CERTIFICATIONS

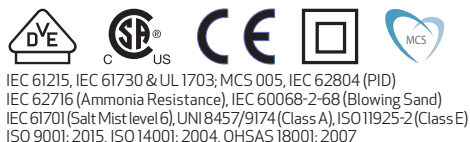

takeaway take-e-way WEEE-compliant recycling scheme
for an easy way

WARRANTY

10 year product warranty
25 year linear power output warranty
(max. degradation in performance of 0.7% p.a.)
See warranty conditions for further details.

17.1% EFFICIENCY
10 YEAR PRODUCT WARRANTY
25 YEAR LINEAR POWER OUTPUT WARRANTY

GENERAL DATA

| | |
|---------------|--|
| Cell type: | 120 half-cut multicrystalline PERC cells 6 strings of 20 cells in series |
| Glass: | 3.2 mm solar glass with anti-reflection surface treatment |
| Backsheet: | Highly resistant polyester polyolefin construction (black) |
| Frame: | Anodized aluminum (black) |
| Junction box: | 3-part, 3 bypass diodes, IP67 rated in accordance with IEC 62790 |
| Cable: | 4 mm ² solar cable, 0.9 m + 1.2 m in accordance with EN 50618 |
| Connectors: | Stäubli MC4 PV-KBT4/PV-KST4 (4mm ²) in accordance with IEC 62852, IP68 only when connected |
| Origin: | Made in Singapore |

MAXIMUM RATINGS

| | |
|--------------------------|----------------------------------|
| Operational temperature: | -40 ... +85°C |
| Maximum system voltage: | 1000 V |
| Design load (+): snow | 367 kg/m ² (3600 Pa)* |
| Maximum test load (+): | 550 kg/m ² (5400 Pa) |
| Design load (-): wind | 163 kg/m ² (1600 Pa)* |
| Maximum test load (-): | 244 kg/m ² (2400 Pa) |
| Max series fuse rating: | 25 A |
| Max reverse current: | 25 A |

* Safety factor 1.5

TEMPERATURE RATINGS*

| | |
|--|---------------|
| Nominal Module Operating Temperature: | 44.6°C (±2°C) |
| Temperature coefficient of P_{MPP} : | -0.36 %/°C |
| Temperature coefficient of V_{OC} : | -0.30 %/°C |
| Temperature coefficient of I_{SC} : | 0.066 %/°C |

*The temperature coefficients stated are linear values

MECHANICAL DATA

| | |
|-------------|---------------------|
| Dimensions: | 1675 x 997 x 38 mm |
| Area: | 1.67 m ² |
| Weight: | 18.5 kg |

Specifications subject to change without notice. Ref: NE-05-07-12 Rev- C 07.17

ANNEX 1: INSTALLATIONS ON WATER PLATFORMS

This section is applicable to the following products only (other module types have not yet been qualified for installations on water platforms):

- REC Peak Energy Series & REC Peak Energy BLK Series
- REC TwinPeak Series & REC TwinPeak BLK Series
- REC TwinPeak 2 Series, REC TwinPeak 2 BLK Series, REC TwinPeak 2 BLK2 Series, REC TwinPeak 2 Mono Series

The above named REC solar panels may be installed on water platform-type mounting systems (note that the certification testing of solar panels does not include testing on these types of systems). When installing any of the above named REC solar panels on fixed position (e.g., anchored) water platforms, for example, floating pontoons, follow the instructions below specific to such applications. Failure to do so will invalidate the warranty.

 **For all installations on water platforms, first advise REC before the start of installation in case of any site specific instructions or constraints.**

INSTALLATION ENVIRONMENT

i) Installation site

- REC solar panels may only be installed on closed bodies of fresh water where water salinity does not exceed 25 mS/cm at 25°C (15 PSU). This specifically excludes mounting on sea and ocean applications.
- The maximum permitted wave height must not exceed 1 m from the crest to the trough of the wave.

ii) Floating platforms

- When using a floating platform, follow the manufacturer's instructions regarding installation, maintenance, inspection and cleaning at all times.

iii) Minimum installation height

- The minimum installation height of REC solar panels on floating platform systems is 15 cm and is defined as the height between the water surface and the lowest edge/part of the panel during normal operation. This will help to shield the panel from direct water spray.

INSTALLATION INSTRUCTIONS

i) System installation

- All cables used for the installation must have sufficient length and slack to prevent damage due to water level changes and wave motions.

 **Negative system grounding is required for REC solar panels installed on a floating platform.**

ii) Mounting panels

- Installation of REC solar panels must be in accordance with the aforementioned standard mounting instructions.
- The junction box should be oriented as far as possible from the water surface according to system design and the junction box, cables and connectors must be protected from direct water splash.
- The installation must allow for sufficient spacing between individual panels, in order to avoid all contact as caused by the natural movement and flexing of the floating structure.

iii) Panel protection

- In areas with high avian activity, additional bird repelling devices may be installed as long as they do not adversely affect system performance, e.g., shading or to the local environment etc.
- If using lightning protection equipment on the floating installation, all relevant local regulations must be respected.

MAINTENANCE

- Regularly inspect the installation to ensure all panels are securely mounted.

 **For installations with high avian activity, system cleaning may be required at more frequent intervals to reduce shading of panels caused by bird defecation.**

SAFETY

- Immediately disconnect the system if the installation or the floating platform exhibits deviation from standard operating conditions.
- In the event of the floating platform being submerged, disconnect the DC connection at the inverter immediately. Do not attempt to salvage panels when sunlight is present.

EC Declaration of Conformity



| | | |
|---|--|--|
| <i>Issuer's name and address:</i> | REC SOLAR PTE. LTD. 20 Tuas South Avenue 14 SINGAPORE 637312 SINGAPORE | |
| <i>Product:</i> | Crystalline silicon terrestrial photovoltaic modules | |
| <i>Type designation:</i> | RECxxxPE [#] RECxxxPE 72* RECxxxPEM 72* RECxxxPE Z-Link RECxxxPE Z-Link-S RECxxxPE Z-Link-M RECxxxPE2 [#] RECxxxPE2 72* RECxxxPE2S 72* RECxxxPE2SM 50 [#] RECxxxPE2SM 72* RECxxxTP [#] RECxxxTP 72* RECxxxTP2 [#] RECxxxTP2 72* RECxxxTP2S* RECxxxTP2S 72* RECxxxTP2SM [#] RECxxxTP2SM 72* | REC Peak Energy Series; REC Peak Energy 72 Series; REC Peak Energy Mono 72 Series; REC Peak Energy Z-Link Series; REC Peak Energy Z-Link-S Series; REC Peak Energy Z-Link-M Series; REC Peak Energy 2 Series; REC Peak Energy 2 72 Series; REC Peak Energy 2S 72 Series; REC Peak Energy 2S Mono 50 Series; REC Peak Energy 2S Mono 72 Series; REC TwinPeak Series; REC TwinPeak 72 Series; REC TwinPeak 2 Series; REC TwinPeak 2 72 Series; REC TwinPeak 2S Series; REC TwinPeak 2S 72 Series; REC TwinPeak 2S Mono Series; REC TwinPeak 2S Mono 72 Series; |
| # in the type can be <u>with or without</u> any of the following suffixes or a combination of these: ECO, BLK, BLK2, IQ; * in the type can be <u>with or without</u> the suffix: XV. | | |
| The object of the declaration described above is in conformity with the relevant Union harmonisation legislation: | | |
| 2014/35/EU | | |
| "Directive of the European Parliament and of the Council on the harmonisation of the laws of the Member States relating to the making available on the market of electrical equipment designed for use within certain voltage limits". | | |
| The technical documentation and full compliance with the standards listed below proves the conformity of the product with the requirements of the above-mentioned EC Directive: | | |
| DIN EN 61215 (VDE 0126-31):2006-02; EN 61215:2005-08 DIN EN 61730-1 (VDE 0126 Teil 30-1):2007-10; EN 61730-1:2007-05 DIN EN 61730-1/A1 (VDE 0126-30-1/A1):2012-09; EN 61730-1:2007/A1:2012 DIN EN 61730-1/A2 (VDE 0126-30-1/A2):2014-01; EN 61730-1:2007/A2:2013 DIN EN 61730-1/A11 (VDE 0126-30-1/A11):2015-08; EN 61730-1:2007/A11:2014 DIN EN 61730-2 (VDE 0126-30-2):2012-09; EN 61730-2:2007 + A1:2012 IEC 61215:2005 IEC 61730-1:2004 IEC 61730-1:2004/AMD1:2011 IEC 61730-1:2004/AMD2:2013 IEC 61730-2:2004 IEC 61730-2:2004/AMD1:2011 | | |
| <u>Remark:</u> The VDE Testing and Certification Institute, Merianstr. 28, 63069 Offenbach (Germany), has tested and certified the product(s) according to these standards. | | |
| <i>Certificate No.</i> | 40039382 | |
| <i>File Reference</i> | 5017538-3972-0001 / 233214 / ET2 / ROT | |
| This declaration is issued under the sole responsibility of the manufacturer and loses its validity if the product is misused or modified without proper authorization from REC. | | |
| | |  Ter Soon Kim – Chief Operating Officer Singapore, May 8, 2017 |

DOCUMENT HISTORY

| Date | Revision Number | Reason |
|-------------|------------------------|--|
| 09.2017 | A | First release of combined installation manual for all REC 60-cell solar panels |
| 11.2017 | B | Textual updates |



REC SOLAR PTE. LTD.
20 TUAS SOUTH AVENUE 14
SINGAPORE 637312
Tel: +65 6495 9228
Mail: post@recgroup.com

www.recgroup.com

